

UserManual

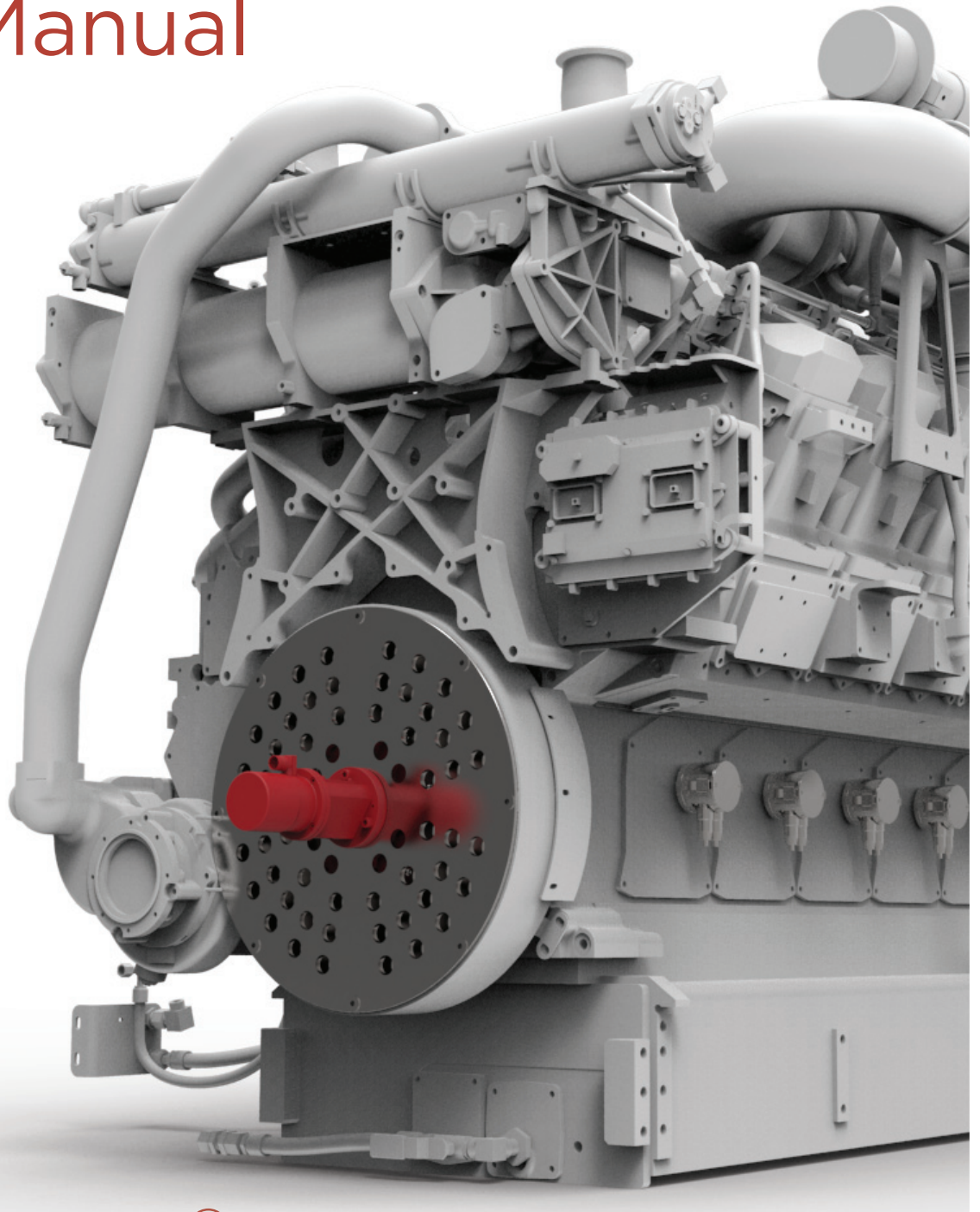

BeCOMS[®] BCom | Bearing Condition Monitoring

Part No.: 1 900 00 0000
Release: 220601 (revision 231102)

Table of revision

Version	Chapter	Changes	Release
01		Original edition	01.06.2022
02	1.5	Declaration of Conformity	02.05.2023
	2.1	Technical Data of SRE and Evaluator	02.05.2023
03	3.4	Requierments for optional PC	02.11.2023

Imprint

Address of Manufacturer

motcom GmbH
Kurt-Schumacher-Str.28-30
66130 Saarbrücken / Germany

Tel +49 (0) 681 8837904-0
Fax +49 (0) 681 8837904-19

Email info@motcomgmbh.com
Internet www.motcomgmbh.com

Contents

1	General.....	1.1
1.1	About this User Manual	1.1
1.2	Warranty	1.1
1.3	Copyright.....	1.2
1.4	Safety instructions	1.2
1.5	Declaration of Conformity.....	1.3
1.6	Scope of delivery.....	1.4
1.7	List of Nomenclature / Abbreviation	1.6
2	General Technical Data	2.1
2.1	Technical Data of Slip Ring Encoder and Evaluator.....	2.1
2.2	Versions of BeCOMS® Systems and Software.....	2.2
2.3	Connection Diagram	2.4
3	System Overview.....	3.1
3.1	Slip Ring Encoder SRE	3.2
3.2	Evaluator	3.3
3.3	Mechanical Adapter and Cable	3.5
3.4	Optional Data Logger PC with Data_Logger Software.....	3.8
4	Functional Description	4.1
4.1	Operating Elements/Settings & Parameters	4.4
4.2	Menu Structure.....	4.5
4.3	System measured values 1 (Default screen)	4.6
4.4	System measured values 2	4.6
4.5	Graphic overview	4.6
4.5.1	BeCOMS graphical data indicator.....	4.6
4.6	SRE advanced infos.....	4.7
4.6.1	SRE advanced infos 1	4.7
4.6.2	SRE advanced infos 2	4.7
4.7	Parameter setup.....	4.7
4.7.1	Setup Parameter	4.8
4.7.2	Setup CPU	4.8
4.7.3	Test Features	4.8

5	Installation and Commissioning	5.1
5.1	Installation Position	5.1
5.2	SRE Mechanical Adjustments	5.2
5.3	Installation of Data Logger PC and BeCOMS® Software	5.3
6	Commissioning	6.1
6.1	Pre-Commissioning Checks	6.1
6.2	Synchronization of the BeCOMS® Sensor SRE with the firing TDC of the first cylinder	6.2
6.3	Data Sampling	6.3
6.4	Alarm Setting and Triggering	6.4
6.5	Alarm Resetting	6.6
6.6	Error Resetting	6.6
6.7	BeCOMS® Data_Logger measurement data storage and management (optional)	6.7
6.8	Compressing Data Files	6.8
6.9	Capturing the Graphic Screens	6.10
6.10	Archiving the Compressed Files	6.11
6.11	Manual Data Analysis for Compartment Localization	6.12
7	Performance / Maintenance Tests	7.1
8	Troubleshooting	8.1
8.1	Hardware trouble shooting	8.1
8.2	Software trouble shooting	8.2
8.3	Missing Control Signal	8.3
8.4	Very low / strong signal on measured values (linear / polar diagram, bar graph)	8.4
8.5	Error code and Error description	8.5
9	Repair	9.1

10 Spare Parts.....	10.1
11 Connection Assembly Instructions.....	11.1
11.1 Connection Cable - RS485 PCI Card to Evaluator.....	11.1
11.2 Assembly of the plug M23	11.4
12 Appendix.....	12.1

1 General

1.1 About this User Manual

These operating instructions describe the BeCOMS® system. By means of the nameplates of each item the BeCOMS® system can be clearly identified.

The operating instructions are to be kept available with the BeCOMS® system at all times.

The operating instructions contain important notes regarding system operation which are intended to ensure safe, appropriate and economical system operation at all times.

The operating instructions must be completely read by each operator before starting to work for the first time. The operator has to ensure that all operating personnel has fully understood the contents of these operating instructions.



The Bearing Condition Monitoring System is sold under the names BeCOMS® and BCom.

For simplification, only BeCOMS® is used throughout this manual.



1.2 Warranty

It is mandatory to read this manual before commencing the repair, assembly or commissioning of the Bearing Condition Monitoring System!

Caution:

The manufacturer's warranty will become void

- If any of the instructions presented within this manual are not followed!
- Use of inadmissible operating media,
- faulty connection,
- preceding work that is not included in the scope of supplies and services,
- non-use of original spare parts and accessories,
- failure to perform required maintenance work.

Please see our Terms and Conditions of Delivery and Performance, available online at: www.motcomgmbh.com.

1.3 Copyright

These operating instructions may be used only by authorised personnel. They may only be given to third parties with the written consent of motcom GmbH.

All documents are protected under copyright law.

Forwarding and duplication of documents, in whole or in part, is not permitted unless authorised in writing.

All documents, drawings, data, and programs remain the exclusive property of motcom GmbH.

They are provided for the agreed purpose only and must not be used for any other purpose.

1.4 Safety instructions

Operation, maintenance and repair of the system and its components may only be carried out by authorised and qualified personnel.

The qualified personnel must have been trained to become:

Technical officer / chief engineer
Engine / Ship mechanic

or possess an equivalent level of training.



Notes regarding system operation which are intended to ensure safe, appropriate and economical system operation at all times.



These notes contain important information and serve to ensure trouble-free functionality.

1.5 Declaration of Conformity

EMC-Directives: 2014/30/EU

Manufacturer motcom® GmbH
Kurt-Schumacher-Str. 28-30
D - 66130 Saarbrücken / Germany
Phone +49 681 8837904-0
Fax: +49 681 8837904-19

We declare on our own responsibility, that the products

Product description motcom®
Bearing Condition monitoring

Type designations BeCOMS® / BCom

are in compliance with following norms:

EN 55011:2018-05/CISPR 11:2015 mod.+A1:2017
EN 55032/CISPR 22
EN 61000-4-2, EN 61000-4-3, EN 61000-4-4
EN 61000-4-5, EN 61000-4-6, EN 61000-4-8

66130 Saarbrücken, Germany, the 26th of January 2023



Dipl.-Ing. Dieter Lott
Managing Director

1.6 Scope of delivery

- BeCOMS® Slip Ring Encoder (SRE)

Is installed with a vibration damper on the free end of the crankshaft via a mechanical adapter set

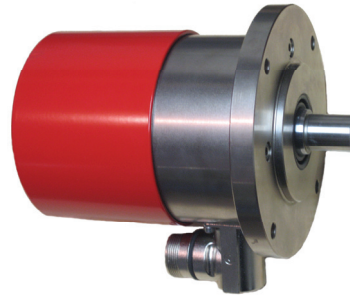

Fig. 1.1 Slip Ring Encoder (SRE)

- BeCOMS® Evaluator

Serves as a local control and for evaluation and display of all values. It can transmit all data via RS485 interface to a computer running the BeCOMS® Data_Logger software (optional) for enhanced visualisation and data storage. The Data_Indicator and motcom Analysis software serves as an offline analysis tool

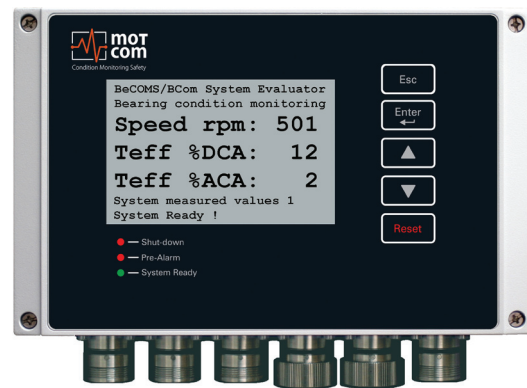

Fig. 1.2 Evaluator

- Mechanical adapter parts and cable for mounting the SRE at the engine

Consisting of:

- 1 engine cover
- 2 adapter disc
- 3 intermediate housing
- 4 cover
- 5 Adapter flange
- 6 Centering tool
- 7 Adapter shaft

cable and connectors

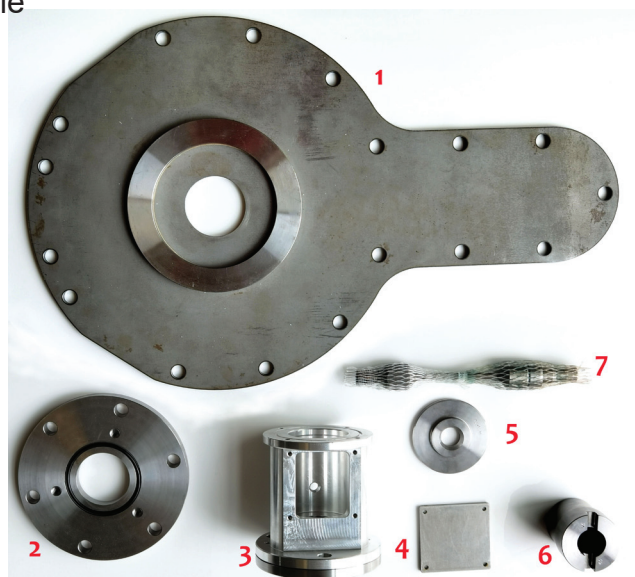

Fig. 1.3 Mechanical Parts and assembled cable

- User Manual incl. CD with Software and instruction manuals

Optional

- Data Logger PC or Notebook, completely installed with:
 - Operating System Windows® 1x, 64 Bit
 - BeCOMS®Data_Logger Software
 - CD incl. Software installation files and a soft copy of the User Manual

- Software
motcom® Loganalyser software, an auto analysis tool for BeCOMS® Logfiles.



1.7 List of Nomenclature / Abbreviation

Abbreviation	Description
BeCOMS®	Bearing Condition Online Monitoring System
Evaluator	Control Device
IPxx	International Protection
LED	Light Emitting Diode
LCD	Liquid Cristal Display
PC	Personal Computer
PCIe	Peripheral Component Interconnect Express
RS485 / EIA-485	Recommended Standard 485
SRE	Slip Ring Encoder

2 General Technical Data

2.1 Technical Data of Slip Ring Encoder and Evaluator

In this chapter we will give you an overview of the main technical data, ordering options and a brief block-wiring diagram. For a detailed pin layout and technical drawings, please refer to Chapter 12 Appendix.

Power Supply:	24V DC +30/-25% Operating Current: max. 2.0 A
Sensitivity:	Adjustable in 5 steps
Relay-Outputs:	Contact load for all relays: max. 60V AC, 1A, 60VA / max. 60V DC, 1A, 60W Alarm 1: 1 relay with 2 ground-free switch-over contacts, usually configured as main alarm. Wire break protection with 33 kOhm resistors (standard) Alarm 2: 1 relay with 1 ground-free switch-over contact, usually configured as pre alarm Ready: 1 relay with 1 ground-free switch-over contact, energized if system is fault-free
Interface:	Serial Interface: • RS485 for standardized industrial, bidirectional communication Communication Protocol: • Modbus • CAN Bus (optional)
User interface:	LC Display 240*128 dots 1 LED red "Shutdown" 1 LED red "Pre-Alarm" 1 LED green "System Ready"
Connection cable:	UL/cUL 12 x AWG 20 Style 2464/1581 300 V 80°C
Environment Conditions:	Operational ambient temperature range: 0°C - 70°C for BCom Evaluator 0°C - 85°C for SRE Storage ambient temperature range: -25°C - 85°C Protection: IP65 for sensor IP66 for Evaluator (DNV-RU-SHIP Pt.4 Ch.9)

2.2 Versions of BeCOMS® Systems and Software

Table 2.1 Features (x = included, o = optional, - = not included)

Hardware	Professional	Advanced	Basic
Power Supply 24V DC +30/-25%	x	x	x
Sensitivity adjustable in 5 Steps	x	x	x
2 alarm relays, Function programmable	x	x	x
1 ready relay	x	x	x
RS485 Interface	x	x	x *
LC-Display 240x128 dots	x	x	x
System status LEDs (System Ready, Prealarm, Shutdown)	x	x	x
PC for data-logging which supports up to 6 systems	x	x	-
Modbus Interface	o	o	o
<i>*only Setup function for Evaluator, no transmission of measured values</i>			
Software Capabilities of the Evaluator			
Setup of BeCOMS® system via the user-interface of the Evaluator or via RS485 (text based setup using a terminal program)	x	x	x
Displays Thermosignal in % alarm level	x	x	x
Displays Thermosignal AC effective in % alarm level	x	x	x
Displays Thermosignal DC effective in % alarm level	x	x	x
Displays Thermosignal in mV	x	x	x
Triggers (Pre)Alarm using AC and DC thermosignal	x	x	x
Auto-check of SRE sensor by Evaluator	x	x	x
Error Monitoring on Display	x	x	x
AC and DC alarmlevels separately adjustable	x	x	x
Displays engine speed in RPM	x	x	x
Triggers overspeed alarm	x	x	x
Different AC alarmlevels for 2 adjustable RPM levels	x	x	x
Shows measured values in a graphic overview display	x	x	x
Recording of data for Damage Localization	x	-	-
Recording data of combustion cycle performance	x	-	-
Data-output via RS485	x	x	x
Data-output via RS485 for combustion cycle	x	-	-
Data-output via RS485 for Damage Localization	x	-	-

Software PC (Logger, Data_Display)	Professional	Advanced	Basic
Required Software shipped with system	X	X	-
Logger version for 2, 4 or 6 BeCOMS® systems included	X	X	-
Displays Relais Status	X	X	-
Displays Thermosignal in % and mV	X	X	-
Displays Thermosignal AC eff. in % alarm level	X	X	-
Displays engine speed in RPM	X	X	-
Displays adjusted DC and AC alarmlevel	X	X	-
Status window with plain text information	X	X	-
Displays setup parameters	X	X	-
Displays thermosignal (% and mV), thermosignal effective and engine speed in one y-t graph	X	X	-
Minimized polar diagram in the main window	X	-	-
Enlarged polar diagram in an own window, incl. integrated engine-geometry for damage localization	X	-	-
Cylinder Speed Difference Diagram for Evaluation of each single Cylinder	X	-	-
Cylinder Thermosignal Difference Diagram for Evaluation of Cylinder Signal	X	-	-
Storing Standard Data in Daily or Hourly Log File	X	X	-
Storing Enhanced Data for Damage Localization in Daily or Hourly Log File	X	-	-
Display Standard Data of Log Files by Data_Indicator software	X	X	-
Display Enhanced Data of Log Files for Damage Localization by Data_Indicator software	X	-	-
Possibility to analyse the Log Files with optional motcom analysis Software	X	X	-

2.3 Connection Diagram

The SRE sensor needs to be connected to the Evaluator connector 6 (see Fig. 2.1).

Ports 1-3 are reserved for 24V power supply, relay output and serial data link, respectively.

For connector details please refer to Chapter 12 Appendix.

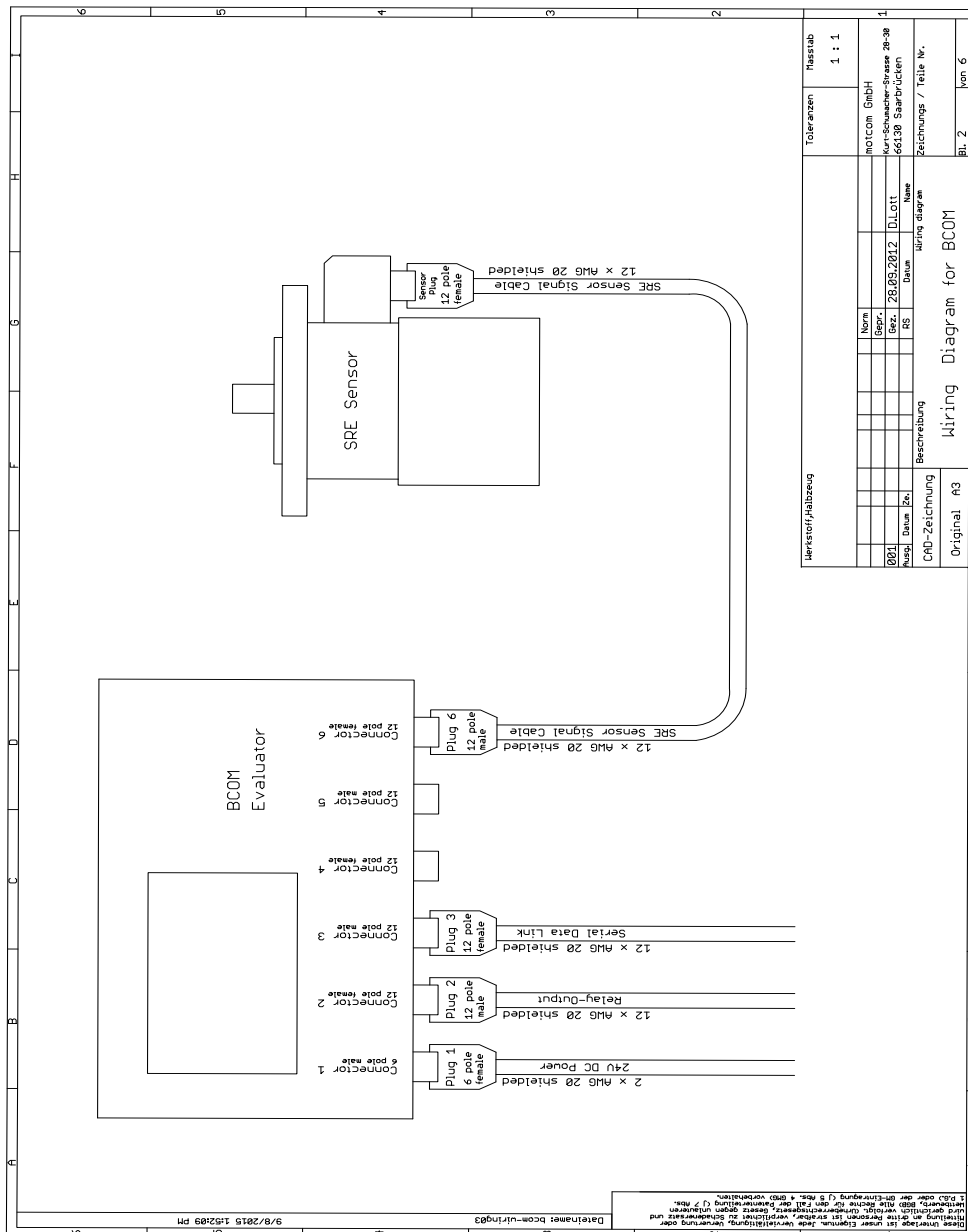

Fig. 2.1 Basic principle of connections

3 System Overview

The BeCOMS® System from motcom consists of:

- one Slip Ring Encoder (SRE), installed with a vibration damper on the free end of the crankshaft via a mechanical adapter set
- one Evaluator serves as a local control and for evaluation and display of all values. It can transmit all data via RS485 interface to a computer running the BeCOMS® Data_Logger software (optional) for enhanced visualisation and data storage. The Data_Indicator and motcom Analysis software serves as an offline analysis tool
- one Set of mechanical parts and cable for mounting the SRE at the engine consists of engine cover, adapter disc, intermediate housing and cover, cable and connectors
- one User Manual incl. CD with Software and instruction manuals

Optional:

- one Data Logger PC/Notebook complete installed with BeCOMS® Data_Logger Software (able to connect with external Data Server over Modbus TCP/IP, see Fig. 3.1) and one CD including Software installation files and a soft copy of this User Manual,

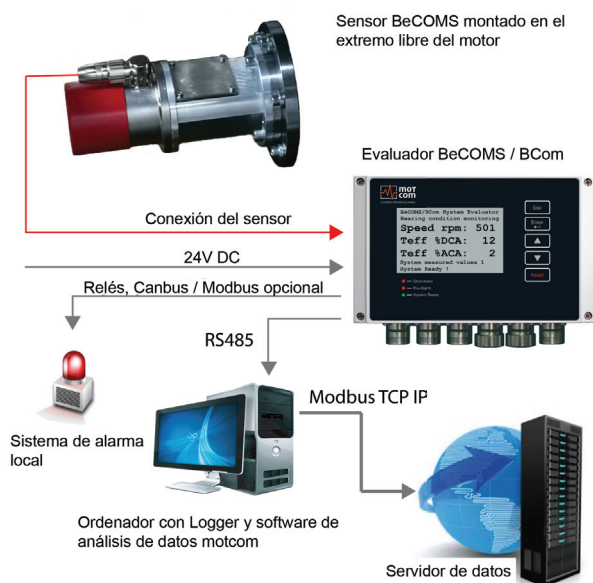

Fig. 3.1 System connection overview

3.1 Slip Ring Encoder SRE

The SRE (ref. Fig. 3.2) is the core part of the detection system as it detects the thermovoltage and rotational signal, ultimately delivering the data for monitoring of the engine.

The SRE is adapted to a specific engine with a custom mounting board/flange. This ensures high compatibility across engine types and an easy dismount of the SRE for maintenance. The SRE's highly rugged design ensures a trouble-free operation under typical conditions (refer to Chapter 2 General Technical Data) and its redundant thermovoltage read-out satisfies even high security demands.



Info: The shaft and the mounting flange are determined, designed and manufactured by motcom GmbH or by its authorized partners for each engine type. Only in this case correct operation and trouble-free transmission of measurement signals are guaranteed.

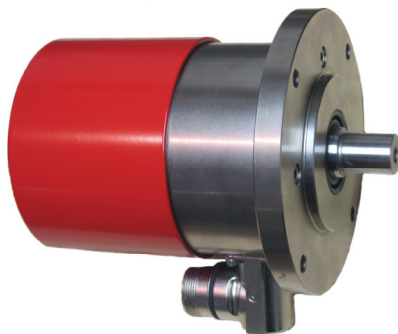

Fig. 3.2 Slip Ring Encoder (SRE)

The connector-set for the socket at the SRE: Art. No. 9 300 12 10000 has the wiring assignment as listed in Table 1, Chapter 12 Appendix, for the connector-set with the Art. No. 9 300 12 20000.

3.2 Evaluator

The Evaluator (Fig.3.3) consists of a IP66 compliant, shock resistant metallic case, a LCD, three LEDs (Shut-down, Pre-Alarm, System Ready), four control keys (**Esc** , **Enter** , **▲** , **▼**) and one reset button **Reset** .

The Evaluator can be operated between 0-70°C and 0-80% relative humidity, suitable for installation close to the engine. It displays all measurement values and parameters and is used for diagnostics of the BeCOMS® system.

The installation of the Evaluator is performed via two assembly rigs. If required, the Evaluator can be mounted vibration-free.

Strain on plugs and cables must be avoided at any time.

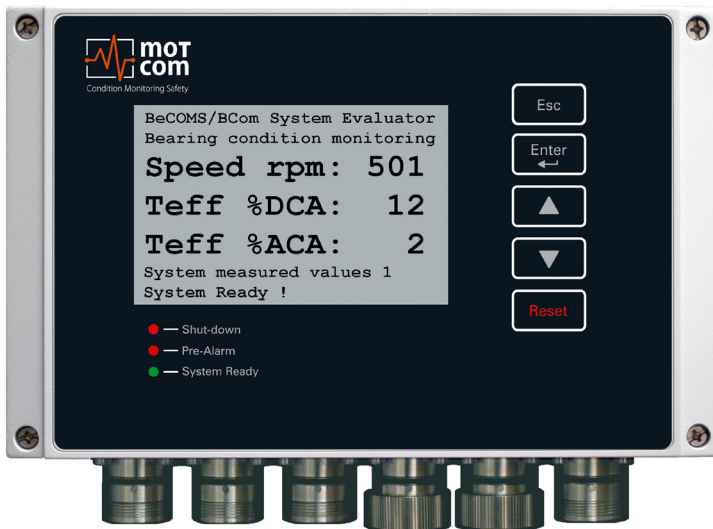

Fig. 3.3 Evaluator

For exact dimensions, please refer to Chapter 12 Appendix



The control keys of the Evaluator are made as film-press buttons. Do not press them with any sharp items like knives, screw-drivers or ball-pens. Just touch the buttons with a slight pressure by a fingertip.

The keypad can be wiped with a mild cleaning agent. Please never use a solvent!



After installation and commissioning by service technicians approved by motcom GmbH, the settings of the Evaluator should not be changed. The Evaluator does not require regular maintenance.

Note: Available Firmware updates are only to be applied by approved service technicians.



Firmware updates are free of charge. Please contact motcom GmbH or an authorized representative for details and further information.

3.3 Mechanical Adapter and Cable

Attention The adapter is tailor-made for each type of engine (for an example see Fig. 3.4); the individual parts must not be removed by untrained / non-motcom personnel. Alignment errors cause high wear and tear and consequential damage. As a result, the shaft and the SRE are damaged, which leads to the failure of the BeCOMS® system.



A guarantee in the event of damage is excluded by motcom GmbH!

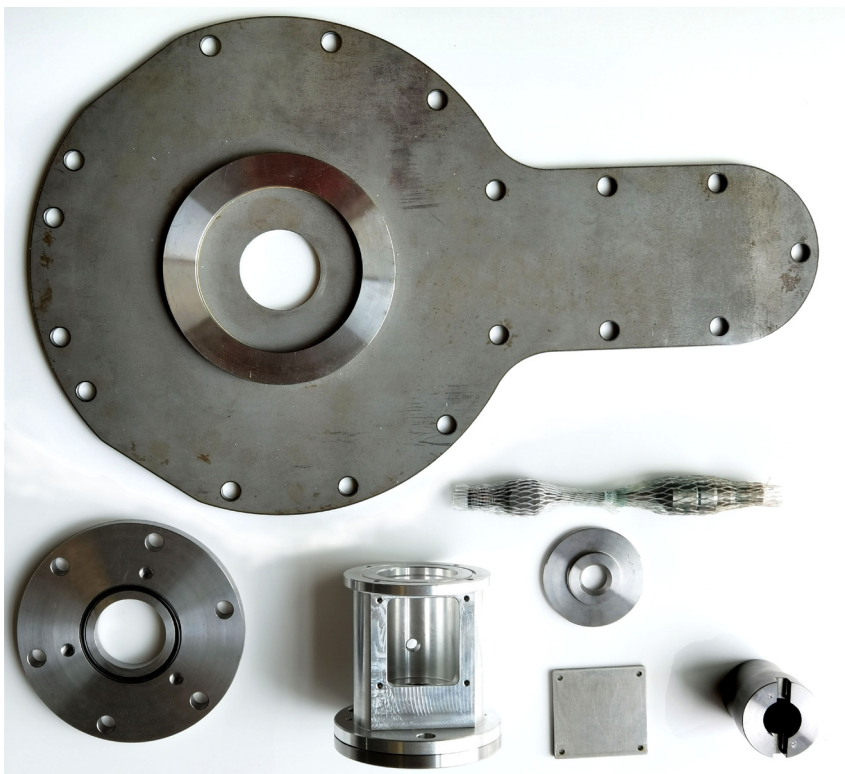

Fig. 3.4 Mechanical parts and assembled cable



Mechanical Structure



For each installation the adapter is tailor-made for a particular type of engine; the individual parts must not be removed by untrained / non-motcom personnel.

Fig. 3.5 shows an example of the adaptation with all the individual parts required.

Alignment errors cause high wear and tear and consequential damage / failure on the shaft and SRE.



A guarantee in the event of damage is excluded by motcom GmbH!

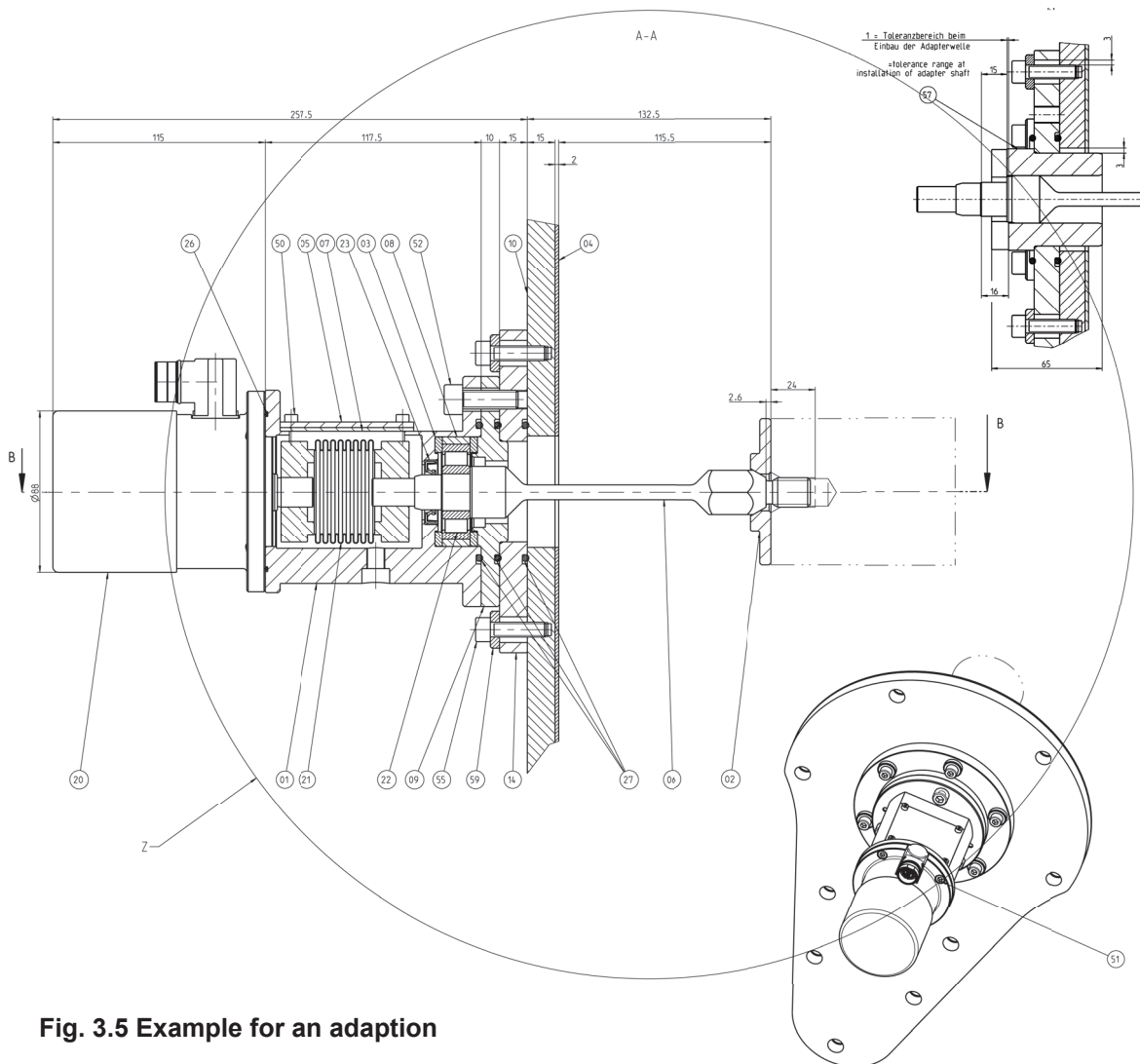

Fig. 3.5 Example for an adaption

Table 3.1 Mechanical parts, shown in Fig. 3.5

01	Intermediate housing	22	Radial cylinder roller bearing
02	Adapter flange	23	Radial shaft seal
03	Isolation washer	26	O-ring
04	Engine seal	27	O-ring
05	Cover	50-52	Cylinder screws
06	Adapter shaft	55	Cylinder screws
07	Cover seal	57	Centering sleeve
08	Isolation bush	59	Washer
09	Intermediate flange		
10	Engine cover		
14	Adapter flange		
20	SRE		
21	Flexible coupling		

3.4 Optional Data Logger PC with Data_Logger Software



This chapter only applies if you are running a BeCOMS® **Advanced** or BeCOMS® **Professional** system! Otherwise, the following information can be ignored.

The BeCOMS® Data_Logger Software enables the user to:

- monitor the measurement remotely on a computer
- store the recorded data in daily/hourly log-files
- display measured signals to allow trained engine operators to localize the damaged part(s)

The Data_Logger Software handles up to six BeCOMS® systems.



The Data_Logger Software does not replace the interconnection of the Evaluator with the engine safety and alarm system

To ensure proper functionality, only motcom GmbH approved PC installations are supported to operate with a BeCOMS® system.

The BeCOMS® folder should be utilized by the operator to be familiar with the software and any safety issues that may arise.

All products mentioned in this manual are to be handled only by trained and instructed personnel.



Any damages, either human or material, caused by the use of the products described in this manual for any purpose other than that intended, is solely the responsibility of the user and not of the manufacturer.

Requirements for the optional PC



The monitoring computer should have the following minimum requirements:

- Intel Core I5, 11th Gen or equivalent
- DVD RW DL Drive
- min. 8GB DDR4 RAM *
- min. 256 GB SSD M.2.P for OS
- min. 1 TB SSD for recording data (approx. 100MB per day per BeCOMS® system) *
- Windows Professional 10 and 11
- Mouse, Keyboard
- at least 3 free PCI/PCIe slots *
- Display resolution full HD
- RS485 Interface (RS232 via optional converter) **

*) depending on number of BeCOMS® applications running in parallel on the same PC

***) The RS485 cable length must not exceed 400 m



motcom GmbH provides optionally either the necessary hardware to convert the RS485 signal of the Evaluator into a standard RS232 PC-signal or a PCI/PCIe card installed in the computer (see Chapter 10 Spare Parts).

4 Functional Description

In this chapter, first we want to give the user an overview of the measurement principle (see Fig.4.1) for a better understanding how the BeCOMS® system works.

The BeCOMS® system can be used on combustion engines and electrical motors, generators, turbines, pumps etc., where the shaft is not electrically isolated from the bearing shells. Using the thermo-electrical (Seebeck) effect for monitoring the condition of the engine/motor, bearings, and slip surfaces, the BeCOMS® system allows to detect a failure even before the performance of the engine is affected.

On internal combustion engines, the BeCOMS® system measures and evaluates continuously the thermovoltage generated between crankshaft and bearing shells. Changes therein can hint to a potentially dangerous engine failure.

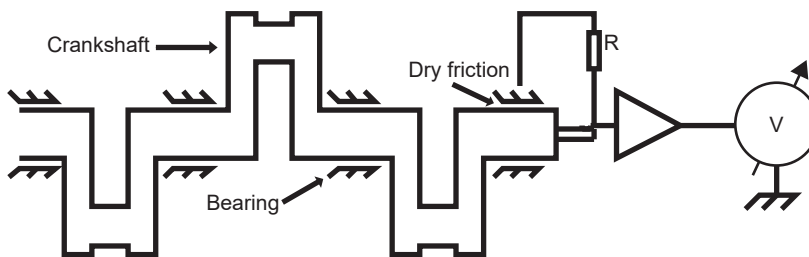

Fig. 4.1 Measurement principle in an engine

This thermovoltage is typically low (< 1 mV) during normal engine operation while the lubrication oil acts as electrical isolation. If the oil film (partially) ruptures, which can be caused for example by presence of metal particles, friction between moving parts increases. This leads to an increase in the thermovoltage which will be detected by the redundant thermovoltage read-out of the BeCOMS® system (see Fig.4.2) which will be checked periodically against an internal reference.

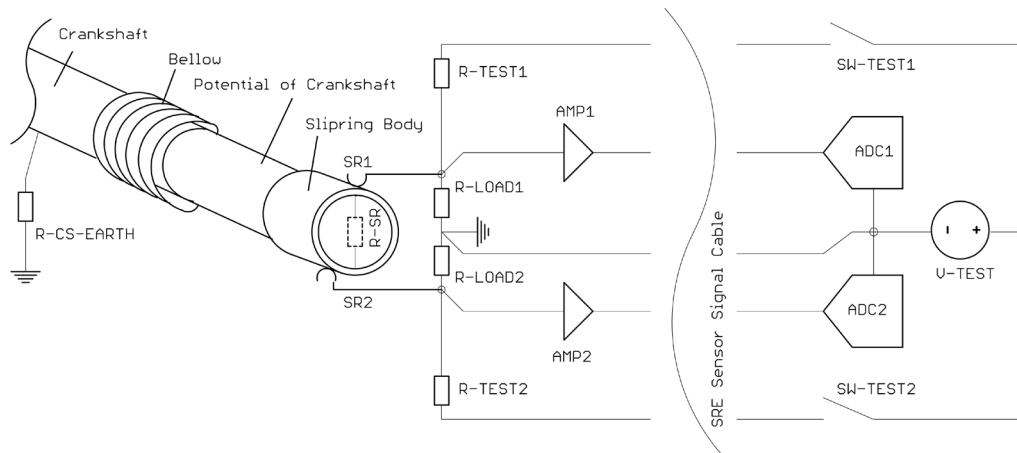

Fig. 4.2 Realizing of a redundant thermovoltage measurement in SRE sensor

The BeCOMS® system is able to precisely detect and localise a beginning failure even before it affects the engine performance, using advanced analysis of the thermovoltage signal combined with other measured values and stored engine-specific data.

Combining this, a localisation to the level of a specific bearing inside the engine is possible.

When a cylinder fires, a higher thermovoltage signal is generated at spots affected by dry friction due to high pressure. These voltage peaks superimposed with data from the incremental encoder and with the firing sequence help to determine the location where the oil film ruptures (see Fig.4.3).

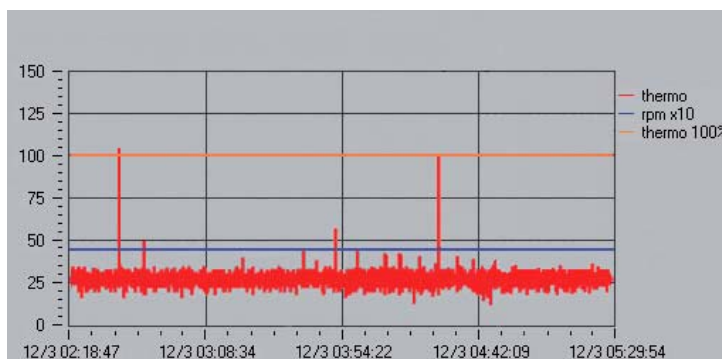

Fig. 4.3 Thermovoltage signal course shown as screenshot of Data_Indicator Software

The thermovoltage and engine rotation speed are displayed at the control device (Evaluator) and optionally remotely on a PC. The information is displayed graphically to ease further decisions on e.g. engine load and/or maintenance, making BeCOMS® an effective and invaluable tool to reduce engine downtime and maintenance costs. A possible integration into alarm control systems/motor management enhances security even further.

During start-up/shut-down procedure, BeCOMS® will detect relatively large thermovoltage peaks compared to steady-state operation (Fig.4.4). This can be explained by a comparatively slow build-up of a lubrication film between moving parts thus an increased friction. After that initial start-up phase, thermovoltage signals are reduced to a motor-specific baseline. Until engine cool down, a distinct level of thermovoltage can still be measured.

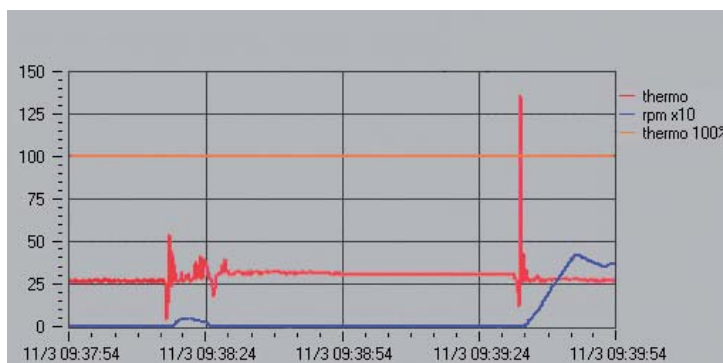

Fig. 4.4 High thermovoltage signal at engine start-up

4.1 Operating Elements/Settings & Parameters

The Evaluator has an LC-Display with a resolution of 240x128 dots, five control buttons and three LEDs that indicate the current system status.

As soon as the Evaluator is powered up, the initial info screens are shown for several seconds, and then the display switches to default screen (shown in Fig.4.5).

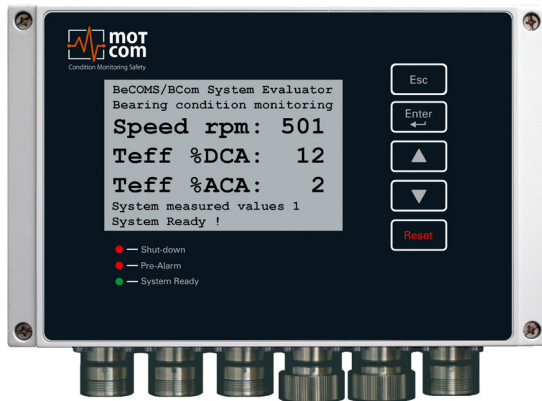







Fig. 4.5 Evaluator default screen:current BeCOMS® measured values

Evaluator button	Symbol in text	Button function
	[Esc]	go to the upper menu level, or cancel the change of system value. If [Esc] is pressed after entering the sublevel of menu items "Setup Parameter" or "Setup CPU", the Evaluator will restart
	[Enter]	enter a sublevel, or confirm a selected system value
	[▲]	move one menu item forward or increase value
	[▼]	move one menu item backward or decrease value
	[Reset]	reset alarm status If Evaluator indicates alarm, press the [Reset] button and hold for 3 sec to reset the alarm status

The BeCOMS® system information and settings are organised in a tree-like menu. The user can view the menu elements on the LC-display, move between them and change some system settings using Evaluator buttons. Changing of system settings is only possible if the PIN is entered before, otherwise the system settings are readonly.

4.2 Menu Structure

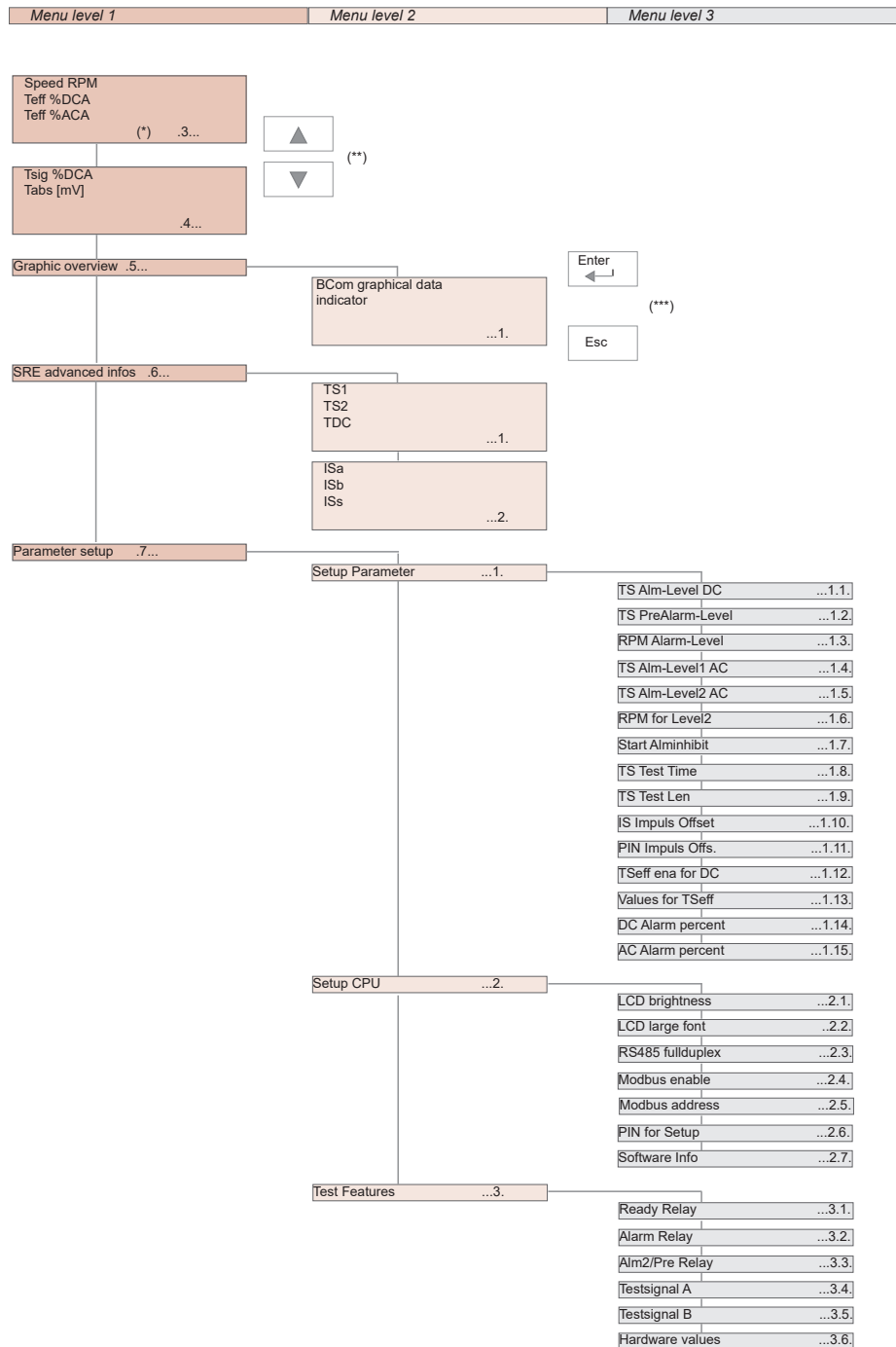

With this menu structure we want to give a complete overview of the levels, followed by explanations and tables on the next pages



Note:

* The numerical indexes correspond to the chapter numbers from the BeCOMS User Manual.

** Menu items are scrolled with arrow buttons : ▲ and ▼

*** Sublevel entry with  button
Sublevel exit to higher level with  button

4.3 System measured values 1 (Default screen)

Menu level 1	Menu level 2	Menu level 3	Descriptions
 <p>Measured values 1 Screenshot</p>			<p>Shows the current BeCOMS® measured values for the connected SRE sensor:</p> <p>Speed rpm: engine rotation speed in RPM Teff %DCA: effective value of thermovoltage in percent of DC alarm level Teff %ACA: effective value of thermovoltage in percents of AC alarm level</p>

4.4 System measured values 2

 <p>Measured values 2 Screenshot</p>			<p>Shows further current BeCOMS® measured values for the connected SRE sensor:</p> <p>Tsig %DCA: thermovoltage in percents of DC alarm level</p> <p>Voltage Tabs [mV]: absolute thermovoltage in mV</p>
---	--	--	---

4.5 Graphic overview

 <p>Graphic overview</p>			
---	--	--	--

4.5.1 BeCOMS graphical data indicator

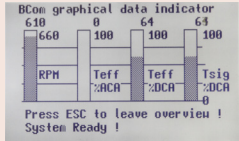
	 <p>Graphical data indicator</p>		<p>The displayed bars are:</p> <p>RPM: engine rotation speed in RPM</p> <p>Teff %ACA: effective value of thermovoltage in percents of AC alarm level</p> <p>Teff %DCA: effective value of thermovoltage in percents of DC alarm level</p> <p>Tsig %DCA: thermovoltage in percents of DC alarm level</p>
--	---	--	---

4.6 SRE advanced infos

Menu level 1	Menu level 2	Menu level 3	Descriptions
BeCOMS / BCom System Evaluator Bearing Condition Monitoring -- SRE advanced infos -- Display more values System Ready ! Advanced SRE infos			

4.6.1 SRE advanced infos 1

	BeCOMS / BCom System Evaluator Bearing Condition Monitoring TS1: 418 TS2: 415 TDC: 1 SRE advanced infos 1 System Ready ! Displays advanced system values 1		TS1: the value at the analog/digital converter of the first thermovoltage measurement channel TS2: the value at the analog/digital converter of the second thermovoltage measurement channel TDC: the calculated indicator of TDC (Top Dead Center) of the cylinder 1. If cylinder 1 is in TDC, the value is 1, otherwise 0.
--	--	--	--

4.6.2 SRE advanced infos 2

	BeCOMS / BCom System Evaluator Bearing Condition Monitoring ISa: 1 ISb: 1 ISs: 0 SRE advanced infos 2 System Ready ! Displays advanced system values 2		ISa: the current value at the A channel of incremental encoder (can be 1 or 0) ISb: the current value at the B channel of incremental encoder (can be 1 or 0) ISs: the current value at the 0 channel of incremental encoder (1 or 0)
--	--	--	---

4.7 Parameter setup

BeCOMS / BCom System Evaluator Bearing Condition Monitoring -- Parameter setup ---- Change of parameters System Ready ! Parameter Setup			Provides access to BeCOMS® parameters, Evaluator settings and test features for viewing and changing.
--	--	--	---

4.7.1 Setup Parameter

Menu level 1	Menu level 2	Menu level 3	Descriptions
	<pre>BeCOMS / BCon System Evaluator Bearing Condition Monitoring -- Setup Parameter ----- up/down-next, ret-select Press ESC to leave ! Change of parameters System Ready !</pre> <p>Setup Parameter</p>		<p>View and change BeCOMS® parameters.</p> <p>If the sublevel was entered (see Table 1 on page 4.9), pressing [Esc] restarts the Evaluator</p> <p>To get write access to these parameters, a PIN must be entered (see Table 2 on page 4.11)</p>

4.7.2 Setup CPU

	<pre>BeCOMS / BCon System Evaluator Bearing Condition Monitoring -- Setup CPU ----- up/down-next, ret-select Press ESC to leave ! Change of parameters System Ready !</pre> <p>Setup CPU</p>		<p>View and change BeCOMS® parameters.</p> <p>If the sublevel was entered (see Table 2 on page 4.11), pressing [Esc] restarts the Evaluator</p>
--	---	--	---

4.7.3 Test Features

	<pre>BeCOMS / BCon System Evaluator Bearing Condition Monitoring -- Test Features ----- up/down-next, ret-select Press ESC to leave ! Change of parameters System Ready !</pre> <p>Test Features</p>		<p>To get access to this menu, a PIN must be entered (see Table 2 on page 4.11).</p> <p>View and use test features of the Evaluator. (see Table 3 on page 4.12)</p>
--	---	--	---

Table 1 Setup Parameter Details

Level 1	Level 2	Level 3	Descriptions
		<pre>BeCOMS / BCon System Evaluator Bearing Condition Monitoring -- Setup Parameter----- TS Alm-Level DC: 3 up/down-next, ret=select Press ESC to leave ! Change of parameters System Ready !</pre> <p>TS Alm-Level DC</p>	<p>The value of DC main alarm level in the range of 0 to 5.</p> <p>The higher the value, the less sensitive is the system.</p> <p>The 0 value disables the DC alarm.</p>
		<pre>BeCOMS / BCon System Evaluator Bearing Condition Monitoring -- Setup Parameter----- TS PreAlm-Level: 70 up/down-next, ret=select Press ESC to leave ! Change of parameters System Ready !</pre> <p>TS PreAlm-Level</p>	<p>The value of DC pre-alarm level in percents of DC main alarm.</p> <p>Possible values: 40 to 100.</p>
		<pre>BeCOMS / BCon System Evaluator Bearing Condition Monitoring -- Setup Parameter----- RPM Alarm-Level: 660 up/down-next, ret=select Press ESC to leave ! Change of parameters System Ready !</pre> <p>RPM Alarm-Level</p>	<p>The value of overspeed alarm in RPM.</p> <p>Possible values: 0 to 3000, step 50.</p> <p>The 0 value disables the alarm.</p>
		<pre>BeCOMS / BCon System Evaluator Bearing Condition Monitoring -- Setup Parameter----- TS Alm-Level1 AC: 3 up/down-next, ret=select Press ESC to leave ! Change of parameters System Ready !</pre> <p>TS Alm-Level1 AC</p>	<p>The value of AC main alarm level in the RPM zone 1.</p> <p>Possible values: 0 to 5.</p> <p>The 0 value disables the alarm.</p>
		<pre>BeCOMS / BCon System Evaluator Bearing Condition Monitoring -- Setup Parameter----- TS Alm-Level2 AC: 3 up/down-next, ret=select Press ESC to leave ! Change of parameters System Ready !</pre> <p>TS Alm-Level2 AC</p>	<p>The value of AC main alarm level in the RPM zone 2.</p> <p>Possible values: 0 to 5.</p> <p>The 0 value disables the alarm.</p>
		<pre>BeCOMS / BCon System Evaluator Bearing Condition Monitoring -- Setup Parameter----- RPM for Level2: 1500 up/down-next, ret=select Press ESC to leave ! Change of parameters System Ready !</pre> <p>RPM for Level2</p>	<p>Engine rotation speed in RPM which defines the boundary between RPM zone 1 and RPM zone 2.</p>
		<pre>BeCOMS / BCon System Evaluator Bearing Condition Monitoring -- Setup Parameter----- Start Alminhibit: Off up/down-next, ret=select Press ESC to leave ! Change of parameters System Ready !</pre> <p>Start Alminhibit</p>	<p>Time interval in seconds immediately after engine start during which the main alarm is disabled.</p>

Level 1	Level 2	Level 3	Descriptions
		<pre>BeCOMS / BCom System Evaluator Bearing Condition Monitoring -- Setup Parameter----- TS Test Time : 1 up/down=next, ret=select Press ESC to leave ! Change of parameters System Ready !</pre> <p>TS Test Time</p>	<p>Time interval between test pulses, possible values: 1 min to 10 min.</p> <p>Test pulses help to check if the SRE sensor functions correct.</p>
		<pre>BeCOMS / BCom System Evaluator Bearing Condition Monitoring -- Setup Parameter----- TS Test Len : 1 up/down=next, ret=select Press ESC to leave ! Change of parameters System Ready !</pre> <p>TS Test Len</p>	<p>The length of test pulse.</p> <p>Possible values: 1 s to 15 s.</p>
		<pre>BeCOMS / BCom System Evaluator Bearing Condition Monitoring -- Setup Parameter----- IS Impuls Offset: 123 up/down=next, ret=select Press ESC to leave ! Change of parameters System Ready !</pre> <p>IS Impuls Offset</p>	<p>The offset between TDC of cylinder 1 and the synchronisation pulse at the channel 0.</p> <p>This value cannot be set at the Evaluator using the "Up" and "Down" buttons. It is used during the impulse offset setup procedure as an indicator.</p> <p>To start the procedure, a PIN must be entered (refer to Table 2 on page 4.11)</p>
		<pre>BeCOMS / BCom System Evaluator Bearing Condition Monitoring -- Setup Parameter----- PIN Impuls Offs:*** up/down=next, ret=select Press ESC to leave ! Change of parameters System Ready !</pre> <p>PIN Impuls Offs</p>	<p>PIN for impulse offset setup, the procedure is the same as described in Table 2 on page 4.11</p>
		<pre>BeCOMS / BCom System Evaluator Bearing Condition Monitoring -- Setup Parameter----- TSeff_ena for DC: 1 up/down=next, ret=select Press ESC to leave ! Change of parameters System Ready !</pre> <p>TSeff_ena for DC</p>	<p>Enable or disable (values 1 and 0 accordingly) calculating effective value of thermosignal in percents of DC alarm level.</p>
		<pre>BeCOMS / BCom System Evaluator Bearing Condition Monitoring -- Setup Parameter----- Values for TSeff: 30 up/down=next, ret=select Press ESC to leave ! Change of parameters System Ready !</pre> <p>Values for TSeff</p>	<p>Number of points for calculating effective value of thermosignal in percents of DC alarm level.</p>
		<pre>BeCOMS / BCom System Evaluator Bearing Condition Monitoring -- Setup Parameter----- DC Alarm percent:100 up/down=next, ret=select Press ESC to leave ! Change of parameters System Ready !</pre> <p>DC Alarm percent</p>	<p>Scale factor for DC alarm level, possible values: 80% to 199%.</p>
		<pre>BeCOMS / BCom System Evaluator Bearing Condition Monitoring -- Setup Parameter----- AC Alarm percent:150 up/down=next, ret=select Press ESC to leave ! Change of parameters System Ready !</pre> <p>AC Alarm percent</p>	<p>Scale factor for AC alarm level, possible values: 80% to 199%.</p>

Table 2 Setup CPU Details

Level 1	Level 2	Level 3	Descriptions
		<pre> BeCOMS / BCom System Evaluator Bearing Condition Monitoring -- Setup CPU ----- LCD brightness : 30 up/down-next, ret=select Press ESC to leave ! Change of parameters System Ready ! </pre> <p>LCD brightness</p>	Brightness of Evaluator LC display in the range of 5 to 100. The higher the value, the brighter is the display.
		<pre> BeCOMS / BCom System Evaluator Bearing Condition Monitoring -- Setup CPU ----- LCD large font : 0 up/down-next, ret=select Press ESC to leave ! Change of parameters System Ready ! </pre> <p>LCD large font</p>	<p>Selection of font</p> <p>0 = 7x12 System 1 = Consolas 2 = Lucidas Console</p>
		<pre> BeCOMS / BCom System Evaluator Bearing Condition Monitoring -- Setup CPU ----- RS485 full duplex : OFF up/down-next, ret=select Press ESC to leave ! Change of parameters System Ready ! </pre> <p>RS485 full duplex</p>	<p>RS485 transmission mode. Possible values:</p> <p>OFF: two-wire mode. Sending and receiving data simultaneously is not possible. ON: four-wire full-duplex mode. Allows communication in both directions simultaneously.</p>
		<pre> BeCOMS / BCom System Evaluator Bearing Condition Monitoring -- Setup CPU ----- Modbus enable : OFF up/down-next, ret=select Press ESC to leave ! Change of parameters System Ready ! </pre> <p>Modbus enable</p>	Enable or disable (values ON and OFF accordingly) the Modbus interface.
		<pre> BeCOMS / BCom System Evaluator Bearing Condition Monitoring -- Setup CPU ----- Modbus address : 3 up/down-next, ret=select Press ESC to leave ! Change of parameters System Ready ! </pre> <p>Modbus address</p>	Modbus address in the range of 0 to 99.
		<pre> BeCOMS / BCom System Evaluator Bearing Condition Monitoring -- Setup CPU ----- PIN for Setup : *** up/down-next, ret=select Press ESC to leave ! Change of parameters System Ready ! </pre> <p>PIN for Setup</p>	<p>PIN for enabling write access to menu items in "Setup Parameter", "Setup CPU" and "Test Features".</p> <p>To enter PIN: press [Enter], the PIN field becomes highlighted. Use [▲] and [▼] buttons to increase or decrease the value. When the correct PIN appears in the value field, press [Enter] again. This screen appears again, and the system parameters can be changed now. If wrong PIN was entered, text in the PIN field will be changed to "P??".</p>
		<pre> BeCOMS / BCom System Evaluator Bearing Condition Monitoring -- Setup CPU ----- Software Info : up/down-next, ret=select Press ESC to leave ! Change of parameters System Ready ! </pre> <p>Software Info</p>	Firmware version of the Evaluator (read-only).

Table 3 Test Features Details

Level 1	Level 2	Level 3	Descriptions
		<pre>BeCOMS / BCom System Evaluator Bearing Condition Monitoring -- Test Features ----- Ready Relay :OFF up/down-next, ret=select Press ESC to leave ! Change of parameters System Ready !</pre> <p>Ready Relay</p>	Switch the Ready relay ON and OFF
		<pre>BeCOMS / BCom System Evaluator Bearing Condition Monitoring -- Test Features ----- Alarm Relay :OFF up/down-next, ret=select Press ESC to leave ! Change of parameters System Ready !</pre> <p>Alarm Relay</p>	Switch the Alarm 1 relay ON and OFF.
		<pre>BeCOMS / BCom System Evaluator Bearing Condition Monitoring -- Test Features ----- Alm2/Pre Relay :OFF up/down-next, ret=select Press ESC to leave ! Change of parameters System Ready !</pre> <p>Alm2/Pre Relay</p>	Switch the Alarm 2 relay ON and OFF.
		<pre>BeCOMS / BCom System Evaluator Bearing Condition Monitoring TS1: 413 TS2: 416 -- Test Features ----- Testsignal A :OFF up/down-next, ret=select Press ESC to leave ! Change of parameters System Ready !</pre> <p>Testsignal A</p>	<p>Switch the test signal on channel A ON and OFF.</p> <p>At the same time the values TS1 and TS2 are displayed (signals from the first and the second thermovoltage measurement channels).</p>
		<pre>BeCOMS / BCom System Evaluator Bearing Condition Monitoring TS1: 542 TS2: 544 -- Test Features ----- Testsignal B :OFF up/down-next, ret=select Press ESC to leave ! Change of parameters System Ready !</pre> <p>Testsignal B</p>	<p>Switch the test signal on channel B ON and OFF.</p> <p>At the same time the values TS1 and TS2 are displayed (signals from the first and the second thermovoltage measurement channels).</p>
		<pre>BeCOMS / BCom System Evaluator Bearing Condition Monitoring -- Test Features ----- Hardware values : up/down-next, ret=select Press ESC to leave ! Change of parameters System Ready !</pre> <p>Hardware values</p>	<p>The screen displays some information about Evaluator hardware.</p> <ul style="list-style-type: none"> - temperature Mainboard - temperature Display - internal clock values

5 Installation and Commissioning

Installation and commissioning of BeCOMS® must be conducted or supervised by personnel from motcom GmbH or its authorized representatives only.



The installation procedure includes training for the site operation personnel. The commissioning data will be provided to the customer as part of the training for later reference.

During the initial installation the current BeCOMS® wiring will be adapted to the existing alarm and monitoring system on site.



For further details please refer to the separate Installation Manual.

5.1 Installation Position

The Slip Ring Encoder is installed at the end of the crankshaft of the combustion engine via an engine specific adapter (refer to Fig.5.1 and Fig.5.2). The evaluator can be installed in the engine room near the engine or, alternatively, in the engine control room. The length of signal cables must not exceed 100 m.

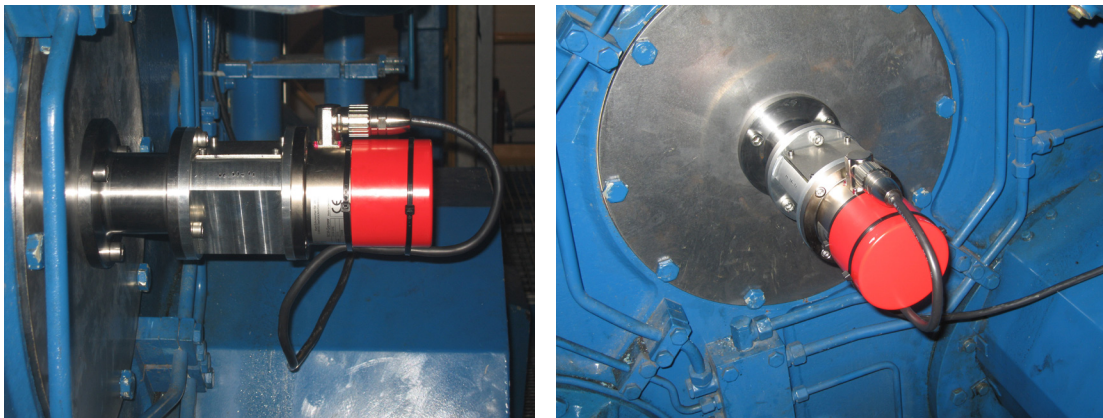

Fig. 5.1 Example for the Installation position

Example for an Installation

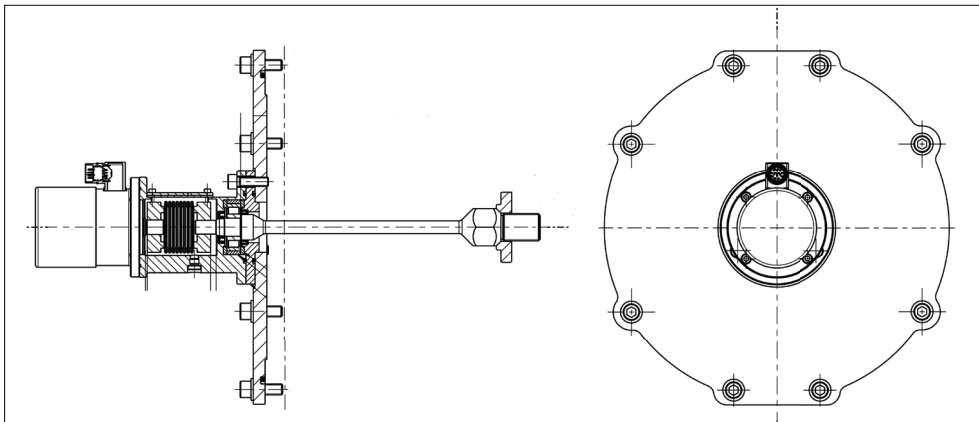

Fig. 5.2 Cut out model of a sample installation

5.2 SRE Mechanical Adjustments



The SRE must only be replaced by personnel from motcom GmbH or its authorized representatives.

Installation and replacement of the SRE requires careful mechanical alignment as well as a precise synchronisation with the engine the SRE is installed to.

To ensure the high level of reliability crucial for operation, two steps must be carried out very carefully:



- **The mechanical adapter must be centered with the engine crankshaft during initial installation, and after each re-installation.**



- **The SRE must be synchronized with the engine crankshaft. This procedure must be carried out during the initial installation, as well as after each dismantlement.**



For the synchronization of the SRE it is necessary to position the engine at the firing TDC (refer to Chapter 6.2 Synchronization of the BeCOMS® Sensor SRE) at cylinder no.1 and to find the incremental encoder impulse offset (on 4-stroke engines the inlet and outlet valves are closed)



Replacing of the SRE only does not affect the centering of the mechanical adapter.

The system only has its full functionality if these steps are carried out carefully!

5.3 Installation of Data Logger PC and BeCOMS® Software

Attention This chapter only applies if you are running a BeCOMS® **Advanced** or BeCOMS® **Professional** system!



The Data_Logger and Data_Indicator software comes pre-installed with the supplied Data Logger PC. The programmes must be configured correctly according to the system specific configuration on site after BeCOMS® commissioning. Please refer to BeCOMS® Data_Logger and Data_Indicator manual for information.

6 Commissioning

A proper cabling between SRE, Evaluator and PC is required to achieve an interference-free signal transmission and thus for the function of the BeCOMS® system.

To ensure this, the following Pre-Commissioning-Checks must be done.

6.1 Pre-Commissioning Checks

Check for the following:

1. correct wiring as given in Chapter 12 Appendix, see Fig. 12.1-12.4
2. correct power supply on Evaluator
3. Evaluator display is on

- 4a. correct power supply on RS-485 converter
- 5a. green power light on (see Fig.6.1)
- 6a. the RS-485 converter rate setting is correct

- 4b. PCI card is built into the PC correctly
- 5b. PCI card driver for the corresponding OS is correctly installed

7. COM-Port of the computer is correctly assigned

Note: Steps 4a – 6a are required if a RS-485 converter is used; steps 4b – 5b are for the case when a PCI card is built into the PC.

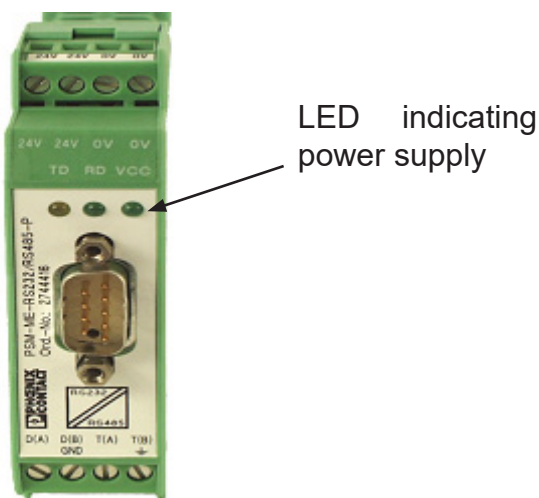

Fig. 6.1 RS-485 converter, LED indicating power supply

6.2 Synchronization of the BeCOMS® Sensor SRE with the firing TDC of the first cylinder

At the installation of the BeCOMS® sensor SRE an one time calibration of the incremental encoder has to be performed. This involves synchronising the neutral point of the incremental encoder with the firing Top Dead Center (TDC) of cylinder 1 by finding offset between them.



It is important that the firing TDC is chosen at four-stroke engines, that is, when inlet and outlet valves are closed.

The following procedure may only be executed by authorized personnel:

- Turn engine to firing TDC of first cylinder (number 1 at inline engine, A1 at v-type engine), all valves must be closed!
- Go to Table 1 (page 4.10) IS Impuls Offset at the Evaluator menu
- Start Impuls Offset detection in the Evaluator menu
- Turn engine in normal rotation direction until Impuls Offset detection is finished
- Leaving IS Impuls Offset Table 1 (page 4.10), the offset will be stored in the Evaluator's EEPROM
- Restart Evaluator
- The synchronization procedure is done



Attention Synchronization must be repeated after all works that required the mechanical connection between crankshaft and SRE sensor to be opened!

6.3 Data Sampling

As soon as the Evaluator is powered up, it starts the initial self check procedure and shows the READY status if all pre-set conditions are fulfilled. This self check procedure is carried out in a certain cycle.

Regardless of the GREEN READY LED status of the Evaluator, if a working SRE is connected to it, the Evaluator samples the signals from the SRE at a certain sampling rate. After that, the Evaluator converts them into digital signals, analyzes, evaluates and displays them on its LC-display.

These data including detected events are continuously made available through the RS485 interface to the installed PC with Data_Logger software for remote monitoring and further processing. It is also possible to set up some Evaluator parameters from the PC using standard Windows HyperTerminal application.

Depending on the configuration, the Data_Logger software can manage up to 6 BeCOMS® systems on a single computer. The measured values and events will be monitored and displayed continuously on the computer, and stored in a distinct directory on the hard disk for each connected BeCOMS® system.

6.4 Alarm Setting and Triggering

There are 3 alarm relays integrated in the Evaluator:

- 1st Alarm relay: always assigned to main alarm, additionally programmable as pre-alarm or over speed alarm
- 2nd Alarm relay: programmable as main alarm or pre-alarm or both and/or over-speed alarm
- 1 Ready relay: indicates the system status

The BeCOMS® has a self test function which is carried out in a certain cycle. If any one of the conditions for System Ready status is not detected the Evaluator switches off the GREEN READY LED and the Ready relay opens. Error code and text error message are shown on the LCD of the Evaluator and also in the event window of Data_Logger on the monitoring computer.

BeCOMS® enables to set different alarm sensitivity levels by defining different thermovoltage signal thresholds as alarm condition. Thermosignal alarm levels are encoded as numbers from 1 to 5 (the higher the number is the less sensitive is the system).

Over-speed alarm level is given in RPM.

Alarm sensitivity levels must be set at the Evaluator. If alarm conditions are fulfilled, the firmware of the Evaluator triggers the corresponding alarm.



The BeCOMS® monitoring software on the computer does **only registering, recording, displaying and storing data!**

For example, the following set of conditions should be met in BeCOMS® in order to trigger a Main Alarm:

- 1) The GREEN READY LED has to be on.
- 2) The measured thermovoltage signals should be higher than the pre-set alarm level over a certain period of time.
- 3) The increase of these measured signals over time should be higher than a certain value.
- 4) The engine rotation speed should be higher than pre-set minimal value.

If Evaluator triggers a Main Alarm it does not necessarily mean that the affected parts have been damaged irreparably.

Depending on the pre-set alarm level and on wiring to the engine site alarm devices, Main Alarm alerts the operator that the tolerated level has been exceeded, indicating that further investigation of BeCOMS® signals is needed, and may initiate an engine shutdown.

By selecting the appropriate sensitivity level, the operator defines up to which extend he would allow moving parts to be affected by friction.

With this information of fault on early stage, the operator is aware of the progressing problem and has enough time for making decisions on engine maintenance and repair.

In case of an alarm triggering, it is shown

- by the LED indicators on the Evaluator
- by the Data_Logger software on the monitoring computer
- by alarm indicators of the engine alarm devices, depending on wiring



6.5 Alarm Resetting

- In case of a Pre-Alarm triggered:

If the conditions for a Pre-alarm does not persists after pre-set time period, the Pre-Alarm will be reset automatically by the system.

- In case of a Main-Alarm triggered:

The Main-Alarm will not be reset automatically by the system even after the conditions that led to it are not met any more. Main-Alarm can only be reset manually at the Evaluator by pressing the RESET button for 3 seconds.

- In case of Over-speed Alarm triggered:

Over-speed Alarm is not being reset automatically by the system either! It must be reset by pressing the RESET button at the Evaluator for 3 seconds



Attention Main-Alarm cannot be reset through the Data_Logger software, but only at the Evaluator by pressing the RESET-Button for 3 seconds.

6.6 Error Resetting

- In case of a System Not Ready status:

Only if all conditions for System Ready status are re-established (e.g. the problem indicated on the LCD of Evaluator is fixed by the operator), the System Ready status will be reactivated automatically by the system.



Exception In case of a communication error, the Evaluator has to be restarted to reactivate the System Ready status!

6.7 BeCOMS® Data_Logger measurement data storage and management (optional)

BeCOMS® Data_Logger is a PC program for displaying and storing the measured data.

For detailed information on Logger software please refer to the BeCOMS® Data_Logger user manual.



Data_Indicator software is used for reading and analysing the BeCOMS® data files.

For further information please refer to the BeCOMS® Data_Indicator user manual.



The daily data files created by BeCOMS® Data_Logger have an approximate size of 100MB per BeCOMS® set. To save hard disk space, older files can be deleted, compressed and/or archived on CD. By compressing a daily log-file with WinRAR, WinZip or other suitable software, the size of the file can be reduced to approx. 10MB.

WinRAR shareware is usually pre-installed on the monitoring PC.

6.8 Compressing Data Files



To compress daily data files with the file extension *.log to *.rar
* symbolizes the name of the data file, which is usually given systematically as follows:
YYYYMMDD_EngineXXX, i.e. 20220117_EngineXXX,
whereas
YYYY: year, i.e. 2022
MM: month, i.e. 01
DD: day, i.e. 17
of the BeCOMS® set on the Engine XXX

using “WinRAR” follow these instructions:

- 1) Click on the desired data file which is to be compressed with the right button of the mouse. A menu should pop up (refer to Fig. 6.2).
- 2) Click on the option “Add to Archive” from the option list.
- 3) Click “OK” (refer to Fig. 6.3.) and the data file *.log will be automatically compressed and a new file *.rar with the same prefix-file name will be created.
- 4) Each log file can be compressed into a single file by repeating the steps 1&2 by selecting the log files *.log one by one.
- 5) If multiple log files are to be compressed into a single rar-file, repeat the above steps 1&2 by selecting all desired log files at once.

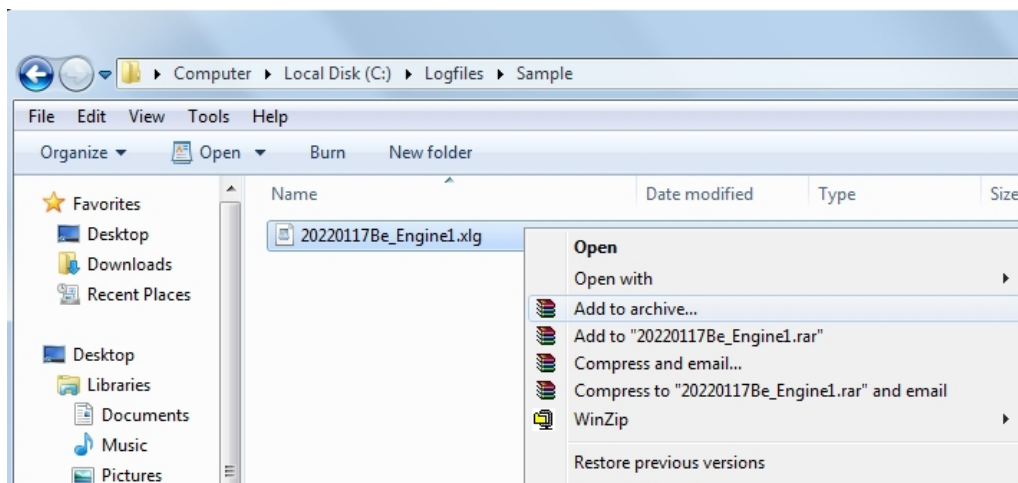

Fig. 6.2 Screenshot of Explorer with Compression menu

Remarks:

Standard settings of the application software “WinRAR” to compress the data files may not be modified:



- 1) Archive format: RAR
- 2) Update mode: Add and update files
- 3) Archiving option: no tag selected
- 4) Compression method: best
- 5) Volume size: not limited
- 6) The original of the data files, which have been compressed, will not be deleted automatically.

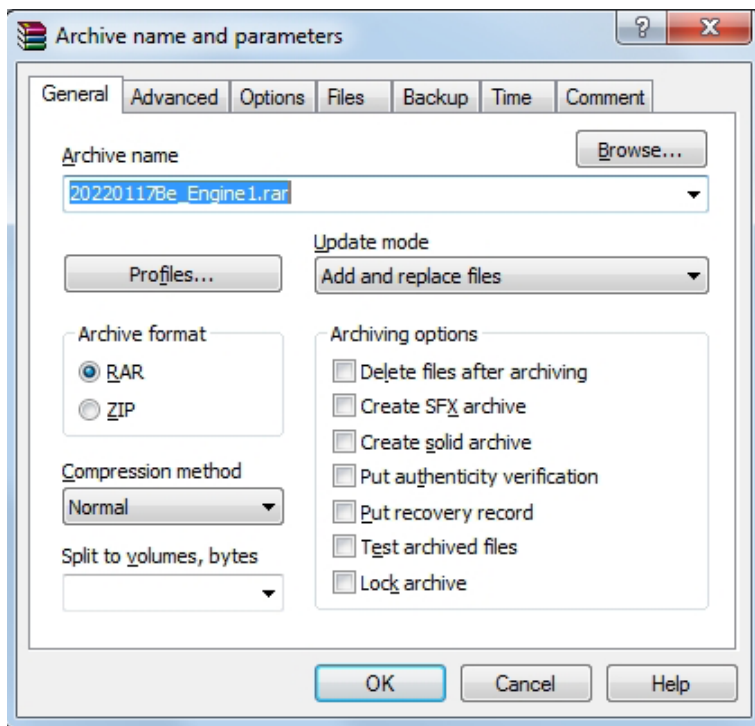

Fig. 6.3 Screenshot “WinRAR” compression software

6.9 Capturing the Graphic Screens

To capture and archive the window screens with the graphical trends of the BeCOMS® signals in daily graphic files with the file extension *.doc using “MS-Word” proceed as follows:

- 1) Preparing/creating a new daily screen file with the file extension *.doc
 - * symbolizes the name of the daily screen file to be chosen, which should be normally named systematically as follows:
YYYYMMDD_EngineXXX, i.e. 20220117_EngineXXX, whereas
MM: month, i.e. 01
DD: day, i.e. 17
YYYY: year, i.e. 2022
Let the new created file open in “MS-Word”
- 2) Change the focus to the BeCOMS® monitoring application (so that you can get a clear screen without unnecessary windows at the back ground of BeCOMS® monitoring application).
- 3) Select the part of the diagram you want to save.
- 4) Press the “alt” and “Print Scrn” button of the keyboard once.
- 5) Then change back to MS-Word so the YYYYMMDD_EngineXXX.doc will be shown again.
- 6) Point to the position you want to insert the captured screen.
- 7) Click the right button of the mouse and click “Paste” from the menu by clicking the left button of the mouse.
- 8) Then the captured screen will be inserted in the doc-file, please resize it according to your need and if necessary please add remarks to the just inserted graphic clips.
- 9) Please repeat the steps 2 to 8 until you have saved all the graphic parts you want (Hint: It is better to keep the graphic curves parts in chronological sequence).
- 10) Then save and close the YYYYMMDD_EngineXXX.doc

To reduce the file size, the YYYYMMDD_EngineXXX.doc files can also be compressed using the same method described in Chapter 6.10 Archiving the Compressed Files on page 6.11.



6.10 Archiving the Compressed Files

To move the compressed data-files *.rar from the daily directory to the monthly archive directory or other storage media (D:\Archive_monthly_data YY.MM, whereas MM: month, i.e. 01; YY: year, i.e. 22,) proceed as follows:

- 1) Select all the data-files *.rar to be moved by marking the first data-files *.rar by
 - a. pointing to the first data-file *.rar to be moved and
 - b. pressing the left button of the mouse once and then press the “Shift-button” of the keyboard, hold it and move the mouse pointer to the last data-files *.rar to be moved and
 - c. press the left button of the mouse once again and release the “Shift-button”. All the selected data-files *.rar change the colour.
- 2) Then click the right button of the mouse.
- 3) Select (by pointing and click the left button) the option “cut” from the pop-up option list.
- 4) Move the pointer to the monthly archive directory (D:\Archive_monthly_data YY.MM) and select it by clicking the left button of the mouse once.
- 5) Then click the right button of the mouse.
- 6) Select (by pointing and click the left button) the option “paste” from the pop-up option list.
- 7) All the selected data-files *.rar will be moved to the monthly archive directory.

6.11 Manual Data Analysis for Compartment Localization

As described in Chapter 4 Functional Description the faulty parts will produce higher thermovoltage signal due to high pressure during firing in the affected cylinders. BeCOMS® Data_Logger software displays the polar log data superposed with the cylinder numbers. This allows a trained engine operator to recognise the following possible causes of the high thermosignal:

- friction between the rotating crankshaft and its bearings. In this case it is possible to identify:
 - compartment where the failure has occurred,
 - the bearings that are affected
- other moving parts not related to the rotating crankshaft. Having experience with this certain engine type, the operator can identify:
 - the exact parts that cause the high thermosignal.

To get reliable failure localization results, a continuous time interval should be analysed in the logfile recorded on the day when failure was registered.

Attention



A general description cannot be given at this point, because the form of thermovoltage signals in BeCOMS® varies depending on the type of engine and application.

In the training session after the commissioning, the engine operators will be trained intensively to perform the localization of faulty compartment and parts specific to their engines.

If no such trained person is available, or if he or she was not able to find the problem, please contact motcom GmbH or its representatives for further analysis of your measurement data.



Please do not send the log file immediately in your first email to us. You will get further information after contacting us.

7 Performance / Maintenance Tests

During operation the Evaluator transmits test signals to the SRE at regular intervals. These signals are displayed depending on the operating state:

1. if the engine runs its crankshaft is electrically isolated from bearings with the lubrication oil film. Test signals are visible among measurement data.
2. on the stopped engine the crankshaft makes electrical contact with the bearing. Test signals are not visible.

The test signals will not be visible either, if the test signal option in the Data_Logger software is disabled. If this option is disabled, the test signal will not be displayed nor stored to the daily log file. This means, that you cannot activate the display of the test signal in Data_Indicator later.



8 Troubleshooting

CAUTION

The manufacturer's warranty will become void if

- the BeCOMS® Evaluator was modified without permission or
- the BeCOMS® Slip Ring Encoder was opened!



8.1 Hardware trouble shooting

The BeCOMS® Data_Logger and Data_Indicator software is designed and tested to run under the following Microsoft operating systems:

- Windows 7
- Windows 8.x
- Windows 1x

Please refer to Chapter 3.4 Optional Data Logger PC with Data_Logger Software for requirements to the personal computer needed for the software.

If a “Not connected” message appears in the event window after you have started “Data_Logger”, the following steps may fix the problem in case the RS-485 converter is used:

- Is the RS-485 converter's green power-LED on? Check the power supply.
- Is the wiring of the RS-485 interface reversed (connection A and B).
This is the most common cause of error!
- Is the RS-485 converter connected to the correct COM port? If connected correctly, the transmit LED (TX) (Fig. 8.1) should blink after measurement start to indicate that computer is sending data.
- If the connection is established, this is confirmed by a “Connected” message in the event window. (Fig. 8.2 on next page)

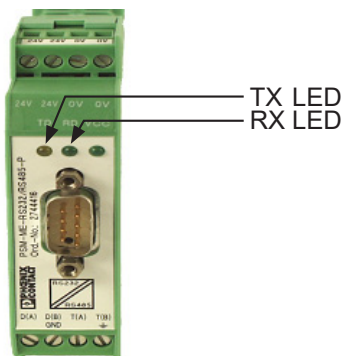

Fig. 8.1 RS-485 converter

8.2 Software trouble shooting

The error messages displayed in Data_Logger are self-explaining, i.e. a communication problem with the Evaluator is depicted in Fig. 8.2 below.

The operators should use the technical acceptable standards to trace the cause of the errors reported and skillfully fix the problem. If the problem cannot be solved, please contact motcom GmbH authorized representatives.

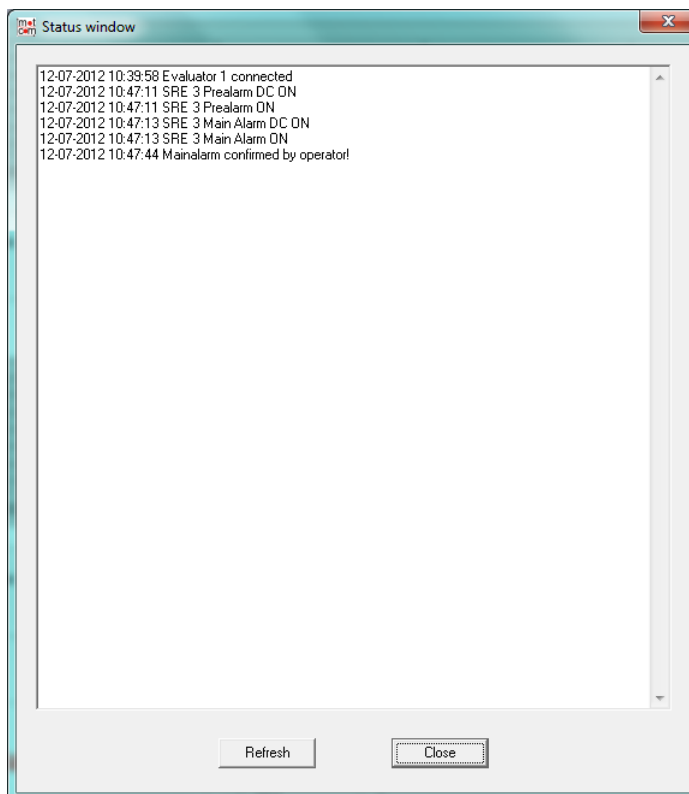





Fig. 8.2 Example of messages displayed in the event window / status window

8.3 Missing Control Signal

1. If the green READY LED of the Evaluator is off and the thermovoltage signal and/or RPM are displayed as zero or unstable on the LCD of the Evaluator (and in Data_Logger) at a running engine, then please conduct the following steps:
 - 1) Check if cable connectors at the cable connecting SRE and the Evaluator are loose, if necessary, fix them
 - 2) If this can not solve the problem, please check the error message reported and contact motcom GmbH or its authorized representatives.

2. If the green READY LED of the Evaluator is on, but only the thermosignal and no RPM is displayed on the LCD of the Evaluator (and in Data_Logger) at a running engine, then please conduct the following steps:
 - 1) Remove the interface housing cover
 - 2) Check whether the metal coupling inside is turning with the engine
Warning: Do not touch moving parts with tools or hands !! 
 - 3) If the coupling is broken it must be exchanged **after the engine is stopped** If it is not turning, retighten it with the necessary torque of 40Nm **after the engine is stopped. Take care all tools are removed prior to re start the engine.** 
 - 4) If the coupling is turning, check if cable connectors at the cable connecting SRE and the Evaluator are loose, and if necessary, fix them
 - 5) Re-assemble the interface housing cover.
 - 6) If you could not solve the problem, please check the error message reported and contact motcom GmbH or its authorized representatives

Attention If you have retightened the metal coupling the synchronization steps in Chapter 5.2 SRE Mechanical Adjustments on page 5.2 must be done. 

In this case, the re-synchronisation of the SRE is mandatory!

8.4 Very low / strong signal on measured values (linear / polar diagram, bar graph)



If the measured values displayed are outside of the physical possibilities of the engine, the problem must be examined in detail - error case!!

Some examples of different causes:

- External interference voltages in the measuring circuit (e.g. grounding of the engine block / generator is bad)
- Wiring problems from the system itself
- the metal coupling can slip, which leads to incorrect speed values
- Interference voltages or grounding problems of the engine block or generator disturb the measuring signal
- Error in the data line by wrong installation of the PC



The recording and interpretation of the signals over a longer period is important. Changes of the signal could be evaluated based on the previous recorded data.

Based on these results suitable measures will derive.

8.5 Error code and Error description

The following messages displayed on the LCD of the Evaluator are possible.



System Ready!

Standard message indicating that the system works and all measured values are in the permitted range.

BeCOMS-Error 04

First pulse sequence of incremental encoder - not connected

BeCOMS-Error 08

Second pulse sequence of incremental encoder - not connected

BeCOMS-Error 16

Synchronization signal of the incremental encoder - not connected

BeCOMS-Error 32

BeCOMS test-signal dead, check all connections

The error codes may be summed up! For example, error code 20 means that the error codes 04 and 16 appeared together.



Possible combined codes are shown on the table 8.1 on the next page!

BeCOMS-Error 99

SRE-Sensor not connected

CPU Error xxx

A CPU error means an error from the EEPROM. This error appears also due to incorrect or incomplete parametrization. Should this error not be fixed after correcting the parameters and restarting please contact the manufacturer or the maintenance service, providing the error code.

01 xx Check parameters of CPU (...)

02 xx Check parameters of BCom (...)

		Single codes			
		32	16	8	4
Summed up codes	12	-	-	X	X
	20	-	X	-	X
	24	-	X	X	-
	28	-	X	X	X
	36	X	-	-	X
	40	X	-	X	-
	44	X	-	X	X
	48	X	X	-	-
	52	X	X	-	X
	56	X	X	X	-
	60	X	X	X	X

Table 8.1 Code combinations

9 Repair

Before any attempts to repair or dismount the BeCOMS® devices because of an assumed defect or failure you should contact motcom GmbH or its authorized partners.



Based on experience, many failures can be cleared easily by fault diagnostics on site. In most cases a repair is not necessary.

Dismounting may only be performed on demand by motcom GmbH or its authorized service representatives. Otherwise, warranty may become void.



A repair of BeCOMS® components is done exclusively by motcom GmbH. Defective parts should be sent to motcom GmbH including detailed failure description.





Please get in contact with the headquarter of motcom GmbH for further assistance.

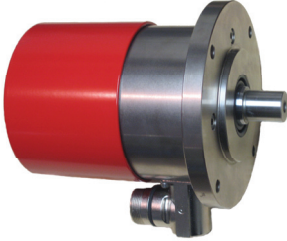
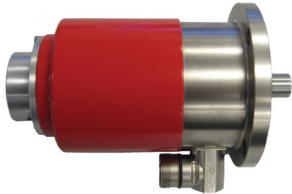
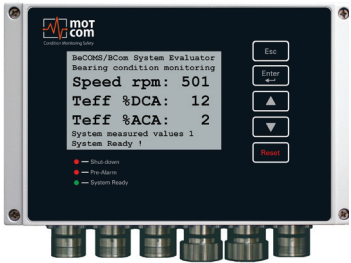
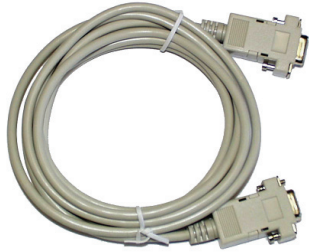

10 Spare Parts

Only the original parts supplied and approved by motcom GmbH should be used; otherwise a proper working system could not be assured.

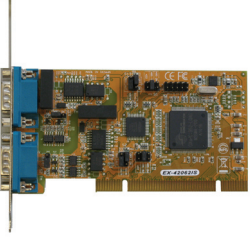
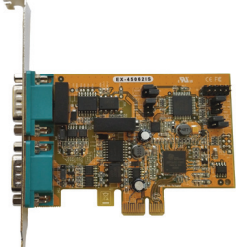

Picture	Description	Part No
	BeCOMS® Slip Ring Encoder (SRE)	1 010 00 20000
	BeCOMS® Slip Ring Encoder (SRE) with throughout shaft	1 010 00 20011
	BeCOMS® Evaluator	1 020 01 00000
	RS232 connection cable for PC to external RS485 converter	9 100 20 00000
	2 core power cable	9 200 02 00000

Picture	Description	Part No
	12 core communication cable	9 200 12 00000
	Sub-D9 connector	9 301 09 10000
	6pol female connector	9 300 06 10000
	12pol female connector	9 300 12 10000
	12pol male connector	9 300 12 20000

Picture	Description	Part No
	RS485 converter PCI card for mounting inside PC	9 100 40 00000
	RS485 converter PCI card for mounting inside PC	9 100 40 00010
	RS485 converter PCIe card for mounting inside PC	9 100 40 00020
	motcom® Loganalyser	1 700 10 01000

11 Connection Assembly Instructions

11.1 Connection Cable - RS485 PCI Card to Evaluator

- Cut away the outer insulation approx. 23mm from the end of the cable

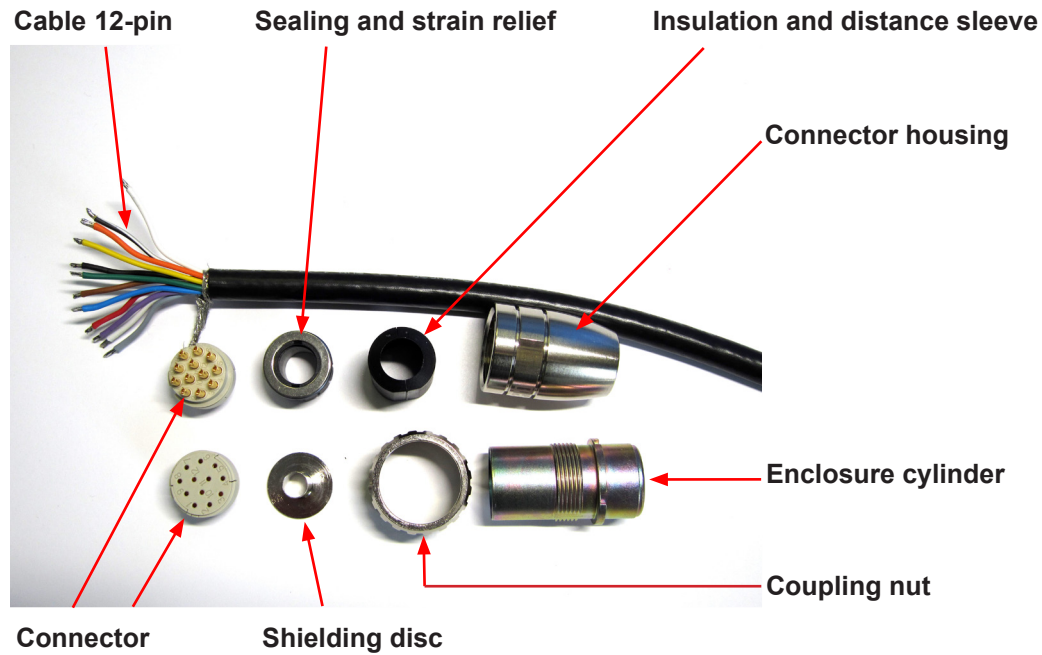

Fig. 11.1 Step 1

- Push back the braided shield
- Push the sealings over the wires

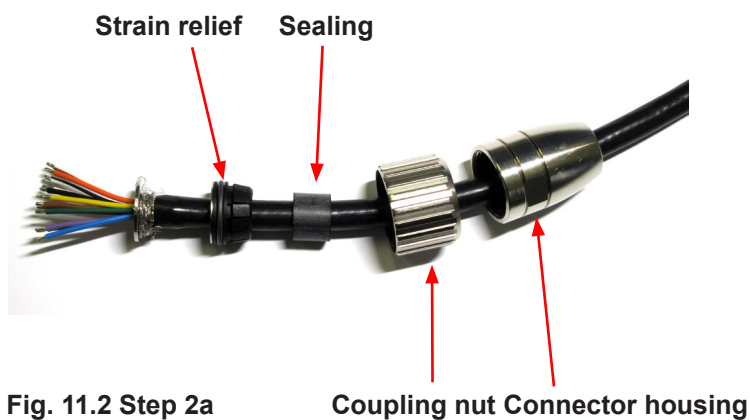

Fig. 11.2 Step 2a

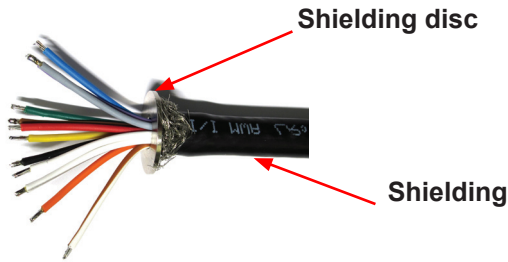

Fig. 11.3 Step 2b

Pin	Signal	Cable Colour	used
1	TXD_RS232	black/white	
2	RXD_RS232	brown/white	
3	CAN_H	orange	
4	CAN_L	yellow	
5	RS485+	green	x
6	RS485-	blue	x
7	RXD_RS485+	violet	x
8	RXD_RS485-	gray	x
9	opt. Modbus+	white	
10	opt. Modbus-	black	
11	GND	brown	
12	GND	red	x

Cable type: 12 x AWG 20 C UL SW

Table 11.1 Pin connection

- Solder wires to pins as shown in table 11.1

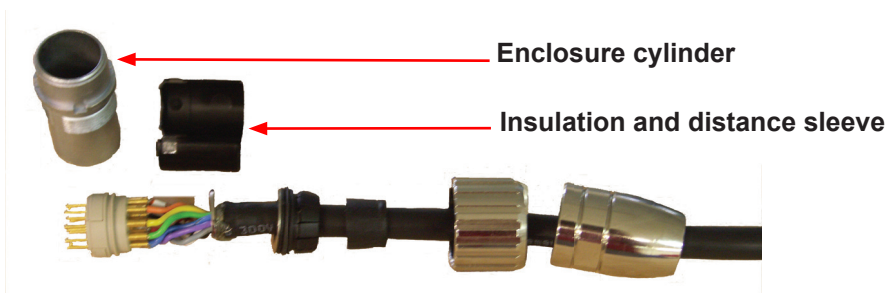

Fig. 11.5 Step 4



- After soldering, pull the insulation and distance relief over the wires
- Pull the enclosure cylinder over the soldered wires
- Finally, seize the connector housing by using the installation wrench and a flat wrench No. 22

For the correct assembling of the plug follow Chapter 11.2 Assembly of the plug M23

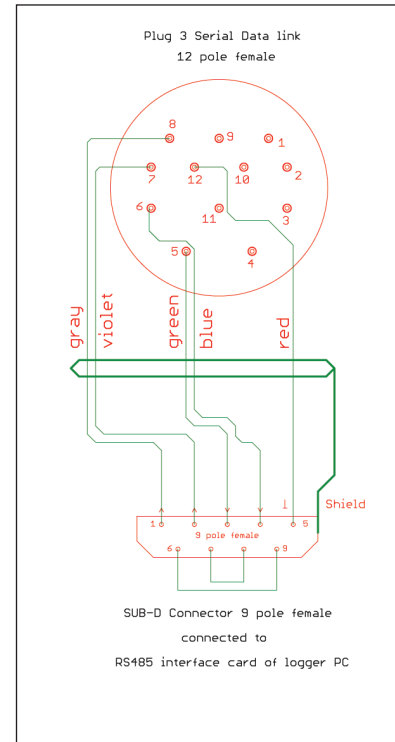
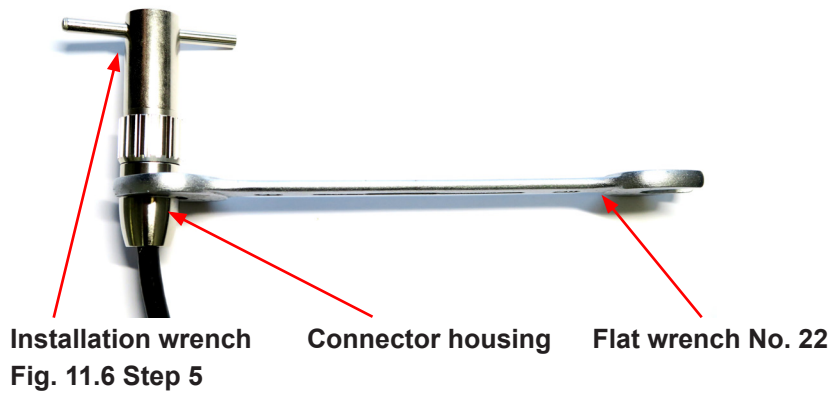

Fig. 11.4 Step 3 Pin connection



Assemble the Sub-D9 connector on the other side of the cable. (Fig 11.8).

Below, you've got two pictures of the connector before and after assembly.

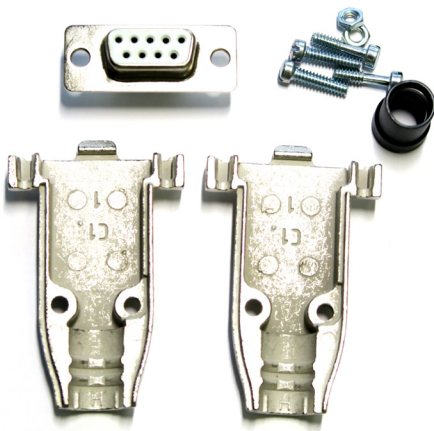

Fig. 11.7 Sub D9 connector before assembly

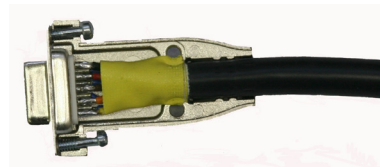

Fig. 11.8 Sub D9 connector after assembly

11.2 Assembly of the plug M23

- Push the components over the cable starting with the adapter (Pos. 1), coupling nut (Pos. 2) and the seal/strain relief element (Pos. 3),
- Cut away the outer insulation approx. 23mm from the end of the cable.
- Push back the braided shield.
- Push the shielding disc (Pos. 4) over the wires and press it against the braided shield.
- Cut back excess of braided shield close to the shielding disc.
- Cut away the plastic foil, filling material and inner insulation.
- Cut away insulation of wires approx. 3.5mm from the end and twist them.
- Solder green wire into pin No. 5 on plug.
- Solder blue wire into pin No. 6 on plug.
- Solder violet wire into pin No. 7 on plug.
- Solder grey wire into pin No. 8 on plug.
- Solder red wire into pin No. 12 on plug.
- Cut off all unused wires.
- Add the distance ring (Pos. 5) between the shielding disc (Pos. 4) and insert ring (Pos. 6).
- Push taper sleeve (Pos. 7) over the insert ring (Pos. 6) and distance ring (Pos. 5). **Make sure the Coding rib is on the right position!**
- Push in cable with shielding disc (Pos. 4) and seal and strain relief element (Pos. 3).

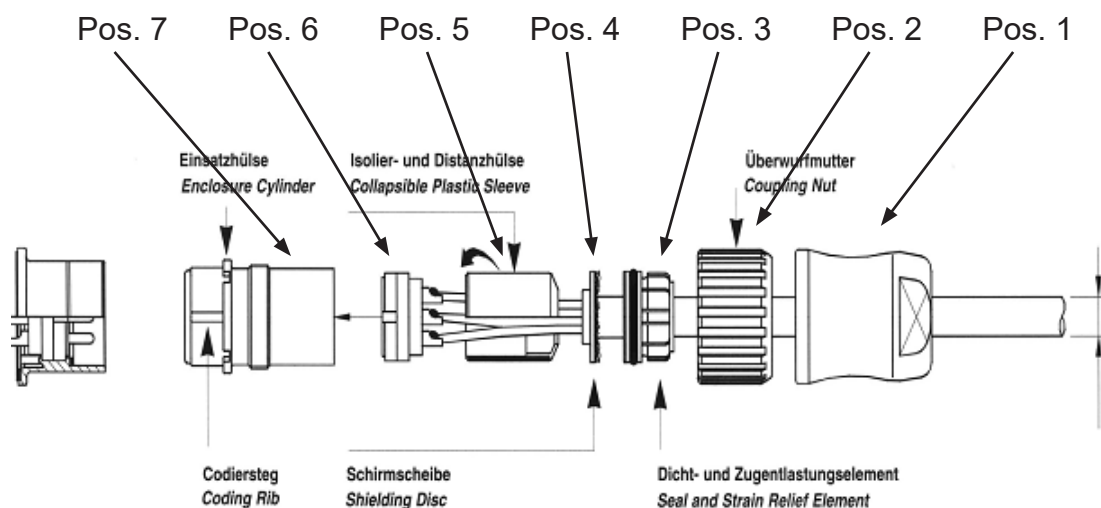

Fig. 11.9 Mounting the plug part. no. 9 300 12 10000 and 9 300 12 20000

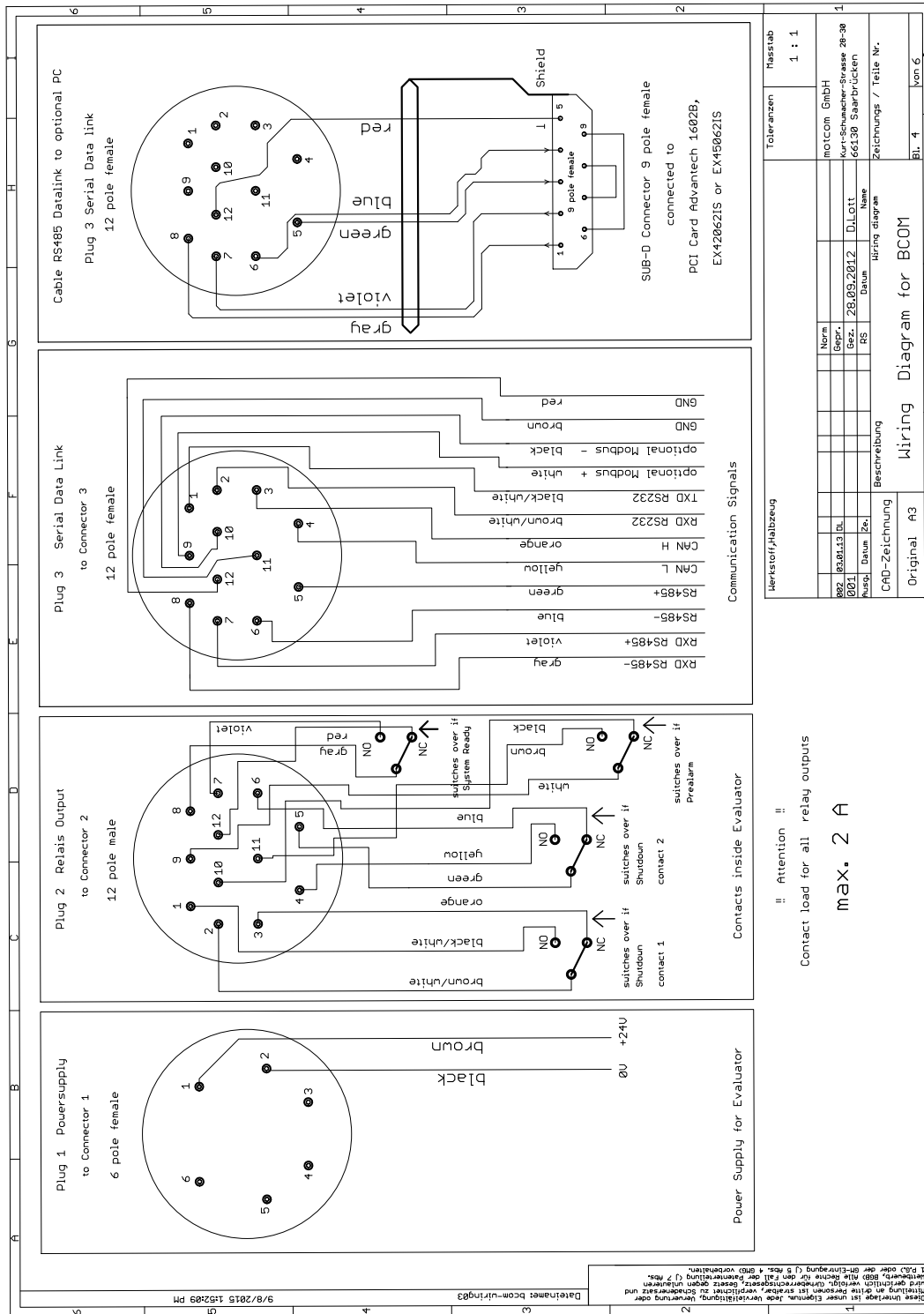

Fig. 12.2 Pin configuration 1-2

See previous pages for further information like wire colors

Pin Configuration of Evaluator plugs						
	1	2	3	4	5	6
Pin	Power Supply	Relays	Serial Data Link	Reserved	Reserved	SRE
1	+24V (brown)	1st Alarm Relay NO	TxD / 232			SRE-1
2	0V (black)	1st Alarm Relay COM	RxD / 232			SRE-2
3		1st Alarm Relay NC	CAN-H			SRE-3
4		2nd Alarm Relay NO	CAN-L			SRE-4
5		2nd Alarm Relay COM	RS485 +			SRE-5
6		2nd Alarm Relay NC	RS485 -			SRE-6
7		Ready Relay NO	RxD + RS485			SRE-7
8		Ready Relay COM	RxD - RS485			SRE-8
9		Pre Alarm Relay COM	GND/ MODBus optional			SRE-9
10		Pre Alarm Relay NC	GND/ MODBus optional			SRE-10
11		Pre Alarm Relay NO	GND			SRE-11
12		Ready Relay NC	GND			SRE-12
Cable Part. No.	2xAWG 20 92000200000	12xAWG 20 92001200000	12xAWG 20 92001200000			12xAWG 20 92001200000
Con- nector Set	93000610000	93001220000	93001210000			93001220000

Fig. 12.5 Pin assignment of Evaluator connectors

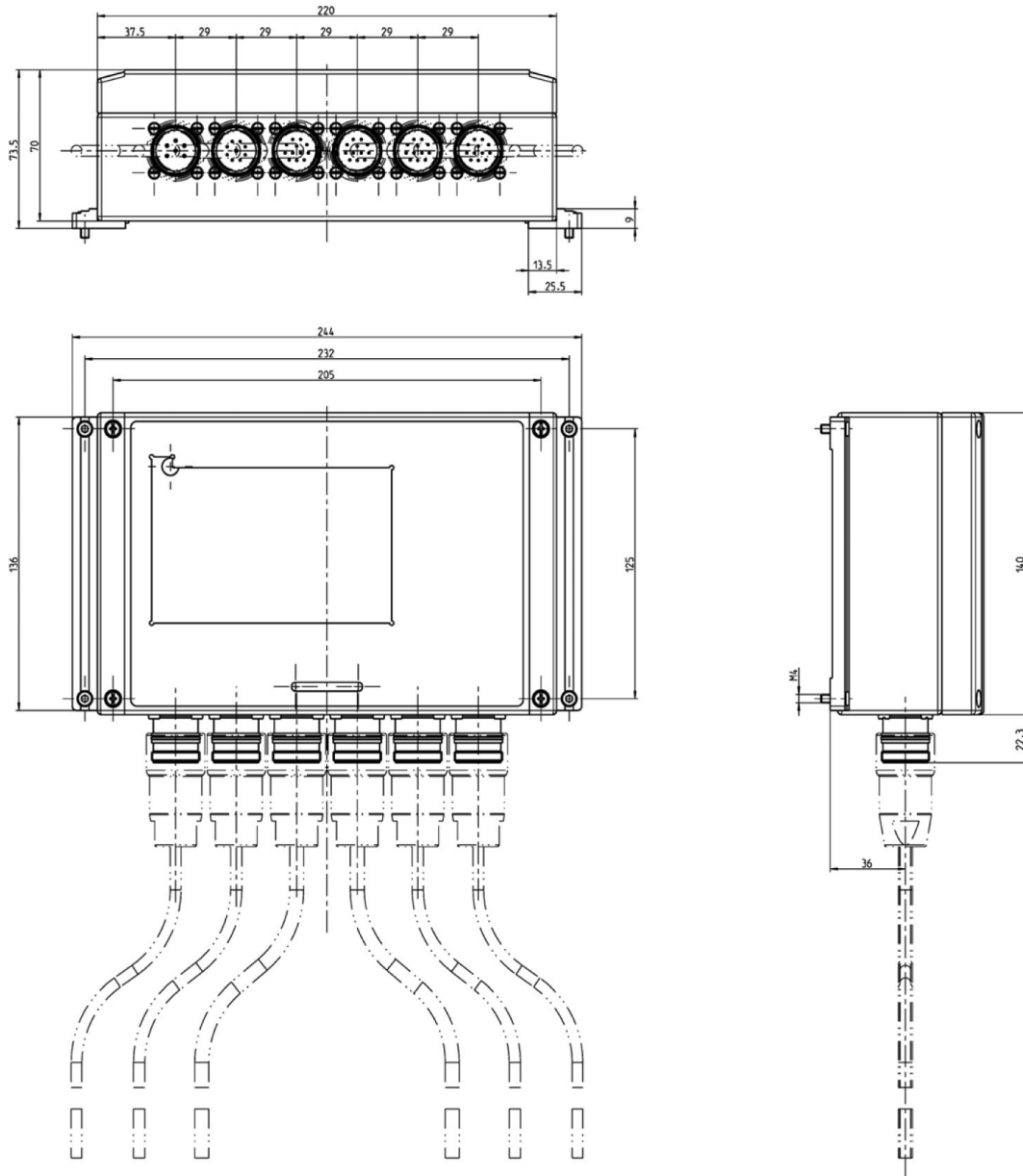

Fig. 12.8 Dimensions Evaluator

motcom GmbH

Kurt-Schumacher-Str.28-30
D-66130 Saarbrücken

Phone +49 (0) 681 – 8837904-0

Fax +49 (0) 681 – 8837904-19

eMail info@motcomgmbh.com

Internet www.motcomgmbh.com